



# Sigma 1-16

## Sigma 1-16 IVD

from serial no. 145728



# Operating Manual

Please retain for later use!



In case of inquiries, please state the following numbers:

Order number:

Serial number:

© Copyright by  
Sigma Laborzentrifugen GmbH  
An der Unteren Söse 50  
37520 Osterode am Harz  
Germany

Tel.: +49 (0) 5522 / 5007-0  
Fax: +49 (0) 5522 / 5007-12  
Web: [www.sigma-zentrifugen.de](http://www.sigma-zentrifugen.de)  
E-mail: [info@sigma-zentrifugen.de](mailto:info@sigma-zentrifugen.de)



---

<b>1</b>	<b>General information</b>	<b>9</b>
1.1	Importance of the operating manual	9
1.2	Intended use	9
1.3	Warranty and liability	9
1.4	Copyright	10
1.5	Standards and regulations	10
1.6	Scope of supply	10
<b>2</b>	<b>Layout and mode of operation</b>	<b>11</b>
2.1	Layout of the centrifuge	11
2.1.1	Functional and operating elements	11
2.1.2	Name plate	12
2.2	Mode of operation	13
2.2.1	Centrifugation principle	13
2.2.2	Area of application	13
2.2.2.1	Speed, radius, and relative centrifugal force	14
2.2.2.2	Density	14
<b>3</b>	<b>Safety</b>	<b>15</b>
3.1	Marking of the unit	15
3.2	Explanation of the symbols and notes	16
3.3	Responsibility of the operator	17
3.4	Operating personnel	17
3.5	Informal safety instructions	17
3.6	Safety instructions	18
3.6.1	Electrical safety	18
3.6.2	Mechanical safety	18
3.6.3	Fire prevention	19
3.6.4	Chemical and biological safety	19
3.6.5	Safety instructions for centrifugation	20
3.6.6	Resistance of plastics	20
3.6.7	Safety of rotors and accessories	21
3.6.7.1	Service life	21
3.7	Safety devices	21
3.7.1	Lid lock device	21
3.7.2	Standstill monitoring system	22
3.7.3	System check	22
3.7.4	Earth conductor check	22
3.8	Measures in the event of hazards and accidents	22
3.9	Remaining hazards	22

## Table of contents

<b>4</b>	<b>Storage and transport .....</b>	<b>23</b>
4.1	Dimensions and weight.....	23
4.2	Storage conditions .....	23
4.3	Notes on transport .....	23
4.4	Packaging.....	24
4.5	Transport safety device.....	24
<b>5</b>	<b>Set-up and connection .....</b>	<b>25</b>
5.1	Installation site .....	25
5.2	Power supply .....	25
5.2.1	Type of connection .....	25
5.2.2	Customer-provided fuses.....	25
<b>6</b>	<b>Using the centrifuge .....</b>	<b>26</b>
6.1	Initial start-up .....	26
6.2	Switching the centrifuge on .....	26
6.2.1	Opening and closing the lid.....	26
6.2.2	Installation of rotors and accessories .....	27
6.2.2.1	Installation of a rotor .....	27
6.2.2.2	Installation of a microhaematocrit rotor .....	28
6.2.2.3	Installation of accessories .....	29
6.2.2.4	Vessels .....	29
6.3	Control System "Spincontrol Basic" .....	30
6.3.1	User interface .....	30
6.3.2	Display.....	30
6.3.3	Starting a centrifugation run.....	31
6.3.4	Interrupting a centrifugation run .....	31
6.3.5	Interrupting a deceleration process.....	31
6.3.6	Speed / Relative centrifugal force (RCF).....	31
6.3.6.1	Changing the speed/RCF value during centrifugation .....	31
6.3.7	Runtime .....	32
6.3.7.1	Changing the runtime during centrifugation.....	32
6.3.7.2	Short run.....	32
6.3.7.3	Continuous run.....	33
6.3.8	Softstart and softstop function .....	33
6.3.9	Rotor selection.....	34
6.3.10	Programs.....	35
6.3.10.1	Saving the current settings.....	35
6.3.10.2	Calling up stored programs .....	35
6.4	Switching the centrifuge off .....	35
<b>7</b>	<b>Malfunctions and error correction .....</b>	<b>36</b>
7.1	General malfunctions .....	36
7.1.1	Emergency lid release .....	37
7.2	Table of error codes.....	38
7.3	Service contact .....	39

**Table of contents**

---

<b>8</b>	<b>Maintenance and service</b> .....	<b>40</b>
8.1	Maintenance .....	40
8.1.1	Centrifuge .....	40
8.1.2	Accessories .....	41
8.1.2.1	Plastic accessories .....	41
8.1.3	Rotors.....	42
8.1.4	Microhaematocrit rotor .....	42
8.1.5	Glass breakage .....	42
8.2	Sterilisation and disinfection of the rotor chamber and accessories .....	43
8.2.1	Autoclaving .....	44
8.3	Service .....	45
8.4	Return of defective centrifuges or parts .....	46
<b>9</b>	<b>Disposal</b> .....	<b>48</b>
9.1	Disposal of the centrifuge .....	48
9.2	Disposal of the packaging .....	48
<b>10</b>	<b>Technical data</b> .....	<b>49</b>
10.1	Ambient conditions .....	50
10.2	Technical documentation .....	51
<b>11</b>	<b>Appendix</b> .....	<b>52</b>
11.1	Range of accessories .....	52
11.1.1	Rotor radii .....	52
11.2	Speed-gravitational-field-diagram .....	53
11.3	Table of the service life of rotors and accessories.....	54
11.4	Resistance data .....	55
11.5	EC declaration of conformity .....	59
11.6	Declaration of conformity – China RoHS 2.....	63
<b>12</b>	<b>Index</b> .....	<b>65</b>





## 1 General information

### 1.1 Importance of the operating manual

A fundamental requirement for the safe and trouble-free operation of the centrifuge is to be familiar with the fundamental safety instructions and all possible hazards.

The operating manual includes important information concerning the safe operation of the centrifuge.

This operating manual and, in particular, the notes on safety and hazards must be observed by all persons operating the centrifuge.

In addition, the local rules and regulations for the prevention of accidents must be complied with.

### 1.2 Intended use

The laboratory centrifuge is suitable for the separation of constituents of different densities in mixtures with a maximum density of  $1.2 \text{ g/cm}^3$ .

The laboratory centrifuge that is marked with IVD is intended for human biological samples, including donated blood and tissue, in conjunction with diagnostic in-vitro applications. This means that it is a medical product in accordance with the IVD directive 98/79/EC.

Only trained, specialised personnel are authorised to use the centrifuge in closed laboratories.

The intended use also includes:

- observation of all of the notes and instructions that are included in the operating manual and
- compliance with the inspection and maintenance instructions.

Sigma Laborzentrifugen GmbH cannot be held liable for any damage resulting from non-compliance.

### 1.3 Warranty and liability

The warranty and liability are subject to our "General Conditions" that were distributed to the operator upon the conclusion of the contract.

Warranty and liability claims are excluded if they are due to:

- improper use.
- non-compliance with the safety instructions and hazard warnings in the operating manual.
- improper installation, start-up, operation, or maintenance of the centrifuge.

## 1 General information

---

### 1.4 Copyright

The copyright concerning the operating manual remains with Sigma Laborzentrifugen GmbH.

The operating manual is solely intended for the operator and their personnel. It includes instructions and information that must not be

- duplicated,
- distributed, or
- communicated in any other way.

Non-compliance may be prosecuted under criminal law.

### 1.5 Standards and regulations

EC declaration of conformity  
(see chapter 11.5 - "EC declaration of conformity")

### 1.6 Scope of supply

#### The centrifuge comprises:

- |   |                                  |
|---|----------------------------------|
| • 1 connection cable with IEC C13 connector   | depending on the voltage variant |
| • 1 socket wrench, size 4 (rotor)             | Part no. 930 050                 |
| • 1 socket wrench, size 6 (emergency release) | Part no. 930 056                 |

#### Documentation:

Operating manual incl. EC declaration of conformity  
(see chapter 11.5 - "EC declaration of conformity")

#### Accessories

According to your order, our order confirmation, and your delivery note.

## 2 Layout and mode of operation

### 2.1 Layout of the centrifuge

#### 2.1.1 Functional and operating elements

- 1 Lid
- 2 Display
- 3 User interface  
(see chapter 6.3.1 -  
"User interface")



*Fig. 1: Total view of the centrifuge*

- 4 Name plate  
(see chapter 2.1.2 -  
"Name plate")
- 5 Mains power switch
- 6 Mains power input



*Fig. 2: Rear view of the centrifuge (example)*

## 2 Layout and mode of operation

### 2.1.2 Name plate

- 1 Manufacturer and registered office
- 2 Type
- 3 Serial number
- 4 Max. density
- 5 Nominal voltage
- 6 Input fuse
- 7 Symbol for special disposal (see chapter 9 - "Disposal")
- 8 CE-mark in compliance with the directive 2006/42/EG
- 9 Part number
- 10 Year of manufacture
- 11 Max. speed
- 12 Max. kinetic energy
- 13 Power consumption

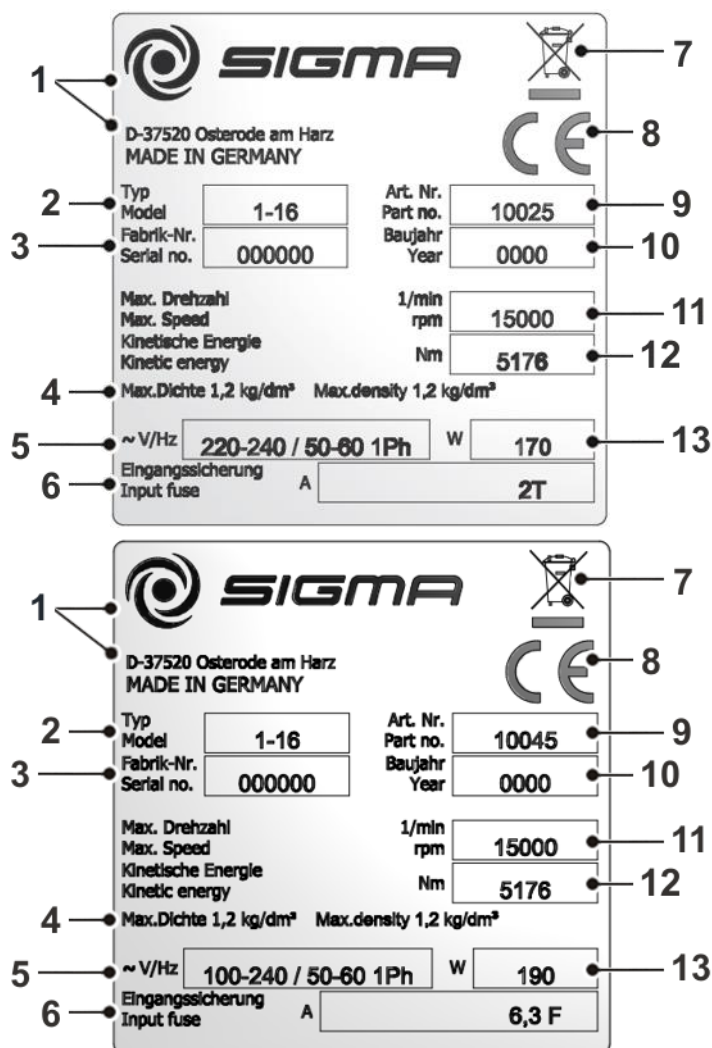

Fig. 3: Examples of name plates

## 2.2 Mode of operation

### 2.2.1 Centrifugation principle

Centrifugation is a process for the separation of heterogeneous mixtures of substances (suspensions, emulsions, or gas mixtures) into their components. The mixture of substances, which rotates on a circular path, is subject to centripetal acceleration that is several times greater than the gravitational acceleration.

Centrifuges use the mass inertia inside the rotor chamber for separating the substances. Due to their higher inertia, particles or media with a higher density travel outwards. In doing so, they displace the components with a lower density, which in turn travel towards the centre.

The centripetal acceleration of an object inside a centrifuge, as the effect of centripetal force, depends on the distance between the object and the axis of rotation as well as on the angular velocity. It increases linearly as a function of the distance with regard to the axis of rotation and quadratically as a function of the angular velocity. The bigger the radius in the rotor chamber is and the higher the speed is, the higher the centripetal acceleration is. However, the forces acting on the rotor also increase.

### 2.2.2 Area of application

Depending on the area of application of the centrifuge and also on the particle size, solids content, and volume throughput of the mixture of substances that is to be centrifuged, there are different types of centrifuges. The areas of application go from household use as a salad spinner or honey separator up to specialised technical applications in the clinical, biological, or biochemical context:

- For numerous clinical examinations, cellular material must be separated from the liquid to be analysed. The normal separation process can be sped up considerably by using laboratory centrifuges.
- In the metal-working industry, centrifuges are used for separating oil from metal cuttings. Dairies use centrifuges in order to separate cow's milk into cream and low-fat milk.
- Particularly big centrifuges are used in the sugar industry for separating the syrup from the crystalline sugar.
- Ultracentrifuges are predominantly used in biology and biochemistry in order to isolate particles, e.g. viruses. They are specifically designed for high speeds up to 500,000 rpm. The rotor moves in a vacuum in order to avoid air friction.

## 2 Layout and mode of operation

---

### 2.2.2.1 Speed, radius, and relative centrifugal force

The acceleration  $g$ , which the samples are subject to, can be increased by increasing the radius in the rotor chamber and by increasing the speed. These three parameters are interdependent and linked with each other via the following formula:

$$\text{Relative centrifugal force RCF} = 11.18 \times 10^{-6} \times r \times n^2$$

$r$  = radius in cm

$n$  = speed in rpm

RCF without any dimension

If two values are entered, the third value is determined by way of the stated formula. If, afterwards, the speed or the radius is changed, the resulting relative centrifugal force will be recalculated automatically by the control unit. If the RCF is changed, the speed will be adapted while the specified radius is maintained.

The speed-gravitational-field-diagram provides an overview of the relationship between speed, radius, and RCF (see chapter 11.2 - "Speed-gravitational-field-diagram").

### 2.2.2.2 Density

The laboratory centrifuge is suitable for the separation of constituents of different densities in mixtures with a maximum density of  $1.2 \text{ g/cm}^3$ . All information concerning the speed of rotors and accessories refers to liquids with a density corresponding to this specification. If the density is above this value, the maximum permissible speed of the centrifuge must be reduced based on the following formula:





















$$n = n_{\max} \times \sqrt{(1,2 / \text{Rho})}$$

$\text{Rho}$  = density in  $\text{g/cm}^3$

### 3 Safety

#### 3.1 Marking of the unit

The following symbols are used for all types of centrifuges manufactured by Sigma:

	Dangerous voltage		On (Power)
	Hot surface		Off (Power)
	Caution! Risk of bruising		Name plate (see chapter 2.1.2 - "Name plate")
	Protective earth (ground)		CE mark in compliance with the directive 2006/42/EC
	Earth (ground)		Do not dispose as part of domestic waste
	g-lock <sup>®</sup> system installed		Unplug the mains plug
	Arrow indicating the direction of rotation		Do not dispose as part of domestic waste
	4°C Guarantee		GS mark (tested safety; only for Germany)
	Centrifuge with heating system		NRTL mark (only for the USA and Canada)
	Medical product in accordance with the IVD directive 98/79/EC (In-vitro diagnostica)		RCM mark (only for Australia)

### 3 Safety



NOTE

Safety indications on the centrifuge must be kept readable at all times. If necessary, they must be replaced.



NOTE

Not all of the symbols/labels are used for this centrifuge type.

### 3.2 Explanation of the symbols and notes

In this operating manual, the following names and symbols to indicate hazards are used:



DANGER

This symbol stands for a **direct** hazard to the life and health of persons.

Non-observance of these symbols **causes** serious health problems up to life-endangering injuries.



DANGER

This symbol stands for a **direct** hazard to the life and health of persons due to electrical voltage.

Non-observance of these symbols **causes** serious health problems up to life-endangering injuries.



WARNING

This symbol stands for a **potential** hazard to the life and health of persons.

Non-observance of these symbols **can** cause serious health problems up to life-endangering injuries.



CAUTION

This symbol indicates a potentially hazardous situation

Non-observance of these notes can cause minor injuries or damage to property.



NOTE

This symbol indicates important information.



### **3.3 Responsibility of the operator**

The operator undertakes to authorise only trained, specialised personnel to work on the centrifuge (see chapter 3.4 - "Operating personnel").

The areas of responsibility of the personnel concerning the operation, maintenance, and care of the unit must be clearly defined.

The safety-conscious work of the personnel in compliance with the operating manual and the relevant EC health and safety directives, and the national laws concerning health and safety and the prevention of accidents must be checked at regular intervals (e.g. every month).

Under the international rules for health and safety at work, the operator is obliged to:

- take measures in order to prevent danger to life or health during work.
- ensure that the centrifuges are used properly and entirely as intended (see chapter 1.2 - "Intended use").
- take protective measures against fire and explosion when working with hazardous substances.
- take measures for the safe opening of the centrifuges.

### **3.4 Operating personnel**

Only trained, specialised personnel are authorised to operate the unit. The persons operating the unit must

- be familiar with the fundamental health, safety, and accident prevention regulations.
- have read and understood this operating manual, in particular the safety sections and warning notes, and confirmed this with their signature.

### **3.5 Informal safety instructions**

- This operating manual is a part of the product.
- The operating manual must be kept at the location of use of the centrifuge. Ensure that it is accessible at all times.
- The operating manual must be handed over to any subsequent owner or operator of the centrifuge.
- Any changes, additions or updates received must be added to the operating manual.
- In addition to the operating manual, the general and local rules and regulations concerning the prevention of accidents and the protection of the environment must also be supplied.
- Safety and danger indications on the centrifuge must be kept readable at all times. If necessary, they must be replaced.

## 3 Safety

### 3.6 Safety instructions

#### 3.6.1 Electrical safety

To reduce the risk of electrical shock, the centrifuge uses a three-wire electrical cord and plug to connect the equipment to earth-ground. To preserve this safety feature:



**DANGER**

- Ensure that the wall socket is properly wired and grounded.
- Check that the mains voltage agrees with the nominal voltage listed on the name plate.
- Do not place vessels containing liquid on the centrifuge lid or within the safety distance of 30 cm around the centrifuge. Spilled liquids may get into the centrifuge and damage electrical or mechanical components.
- Work on the power supply system must only be performed by certified electricians.
- Inspect the electrical equipment of the unit regularly. Defects such as loose or burnt cables must be eliminated immediately.

#### 3.6.2 Mechanical safety

In order to ensure the safe operation of the centrifuge, observe the following:



**WARNING**

- Do not open the lid when the rotor is in motion!
- Do not reach into the rotor chamber when the rotor is in motion!
- Do not use the centrifuge if it was installed incorrectly.
- Do not use the centrifuge without panels.
- Do not use the centrifuge if the rotors and inserts show signs of corrosion or other defects.
- Never operate the instrument without a rotor installed.
- Only use the centrifuge with rotors and accessories that have been approved by the manufacturer. In case of doubt, contact the manufacturer (see chapter 7.3 - "Service contact").
- Do not hold your fingers between the lid and the housing when closing the lid. Risk of crushing!
- Defective lid relieving devices could cause the centrifuge lid to fall (contact the service department, if necessary). Risk of crushing!
- Do not hit or move the centrifuge during its operation.
- Do not lean against or rest on the centrifuge during its operation.
- Do not spin any substances that could damage the material of the rotors and buckets of the centrifuge in any way. Highly corrosive substances, for example, damage the material and affect the mechanical strength of the rotors and buckets.
- Stop the centrifuge immediately in the event of a malfunction. Eliminate the malfunction (see chapter 7 - "Malfunctions and error correction") or inform the service department of Sigma Laborzentrifugen GmbH (see chapter 7.3 - "Service contact").

**WARNING**

- If the housing becomes damaged, do not use the centrifuge. Contact the service department of Sigma Laborzentrifugen GmbH (see chapter 7.3 - "Service contact").
- Ensure that all repairs are performed only by authorised and specialised personnel.
- Prior to any start-up, check the centrifuge, rotor, and accessories for signs of damage that can be discerned from the outside. Special attention must be paid to all of the rubber parts (e.g. motor cover, lid seal, and adapters) in terms of visible structural changes. Defective parts must be replaced immediately.
- Open the centrifuge when it is not in use so that moisture can evaporate.

### 3.6.3 Fire prevention

**DANGER**

- Do not spin explosive or inflammable substances.
- Do not use the centrifuge within hazardous locations.

### 3.6.4 Chemical and biological safety

If pathogenic, toxic, or radioactive samples are intended to be used in the centrifuge, it is in the responsibility of the user to ensure that all necessary safety regulations, guidelines, precautions, and practices are adhered to accordingly.

**DANGER**

- Infectious, toxic, pathogenic, and radioactive substances may only be used in special, certified containment systems with a bio-seal in order to prevent the material from being released.
- Take suitable precautions for your own safety if there is a risk of toxic, radioactive, or pathogenic contamination
- Materials that chemically react with each other with a high level of energy are prohibited.

**WARNING**

- Keep informed about local measures to avoid harmful emissions (depending on the substances to be centrifuged).
- Protective clothing is not required for the operation of the centrifuge. The materials to be centrifuged may, however, require special safety measures (e.g. centrifugation of infectious, toxic, radioactive, or pathogenic substances).

### 3 Safety

#### 3.6.5 Safety instructions for centrifugation

For safe operation, observe the following before starting the centrifuge:



**WARNING**

- Ensure that the centrifuge was set up properly (see chapter 5 - "Set-up and connection").
- Maintain a safety distance of at least 30 cm (12 inches) around the centrifuge.
- Do not store any dangerous goods in the centrifuge area.
- Do not stay in the safety area longer than what is absolutely necessary for the operation of the centrifuge.
- Only use the centrifuge with rotors and accessories that have been approved by the manufacturer. We explicitly warn against the use of equipment of poor quality. Breaking glass or bursting vessels can cause dangerous imbalances at high speeds
- Ensure that rotor and buckets are correctly fitted (see chapter 6.2.2.1 - "Installation of a rotor").
- Observe the instructions on the installation of accessories (see chapter 6.2.2.3 - "Installation of accessories").
- The rotor must be loaded in a rotationally symmetrical manner at equal weights.
- If liquids with a density  $> 1.2 \text{ g/cm}^3$  are used, reduce the speed (see chapter 2.2.2.2 - "Density").
- Do not use the centrifuge if the rotor is loaded asymmetrically.
- Do not use the centrifuge with tubes that are excessively long.



**WARNING**

#### 3.6.6 Resistance of plastics

Chemical influences have a strong effect on the polymeric chains of plastics, and, therefore, on their physical properties. Plastic parts can be damaged if solvents, acids, or alkaline solutions are used.



**NOTE**

- Refer to the resistance data (see chapter 11.4 - "Resistance data")!

### 3.6.7 Safety of rotors and accessories

#### 3.6.7.1 Service life

The rotors and accessories have a limited service life.



**WARNING**

- Perform regular checks (at least once per month) for safety reasons!
- Pay special attention to changes, such as corrosion, cracks, material abrasion, etc.
- After 10 years, they must be inspected by the manufacturer.
- After 50,000 cycles, the rotor must be scrapped for reasons of safety.
- If other data concerning the service life are engraved on the rotor or bucket, these data shall apply accordingly. For example, a bucket with the engraving "max. cycles = 10,000" has a service life of 10,000 cycles, and a rotor with the engraving "Exp. date 02/20" must be scrapped in February 2020 at the latest (see figure).
- If a specification concerning the maximum number of cycles **and** a specification concerning the service life (i.e. a date) are provided, the specification that occurs first shall apply.



Fig. 4: Different service life – engraving on the bucket/rotor



**NOTE**

- Refer to the table of rotors and accessories with a different service life (see chapter 11.3 - "Table of the service life of rotors and accessories")!

## 3.7 Safety devices

### 3.7.1 Lid lock device

The centrifuge can only be started when the lid is properly closed. The electrical lock must be locked. The lid can only be opened when the rotor has stopped. If the lid is opened by way of the emergency release system during operation, the centrifuge will immediately switch off and decelerate brakeless. If the lid is open, the drive is completely separated from the mains power supply, i.e. the centrifuge cannot be started (see chapter 7.1.1 - "Emergency lid release").

### 3 Safety

---

#### 3.7.2 Standstill monitoring system

Opening of the centrifuge lid is only possible if the rotor is at a standstill. This standstill is checked by the microprocessor.

#### 3.7.3 System check

An internal system check monitors the data transfer and sensor signals with regard to plausibility. The system continuously performs a self-check and identifies malfunctions. Malfunctions are indicated by error messages with a number in the speed/rcf display (see chapter 7.2 - "Table of error codes").

#### 3.7.4 Earth conductor check

An earth conductor check can be carried out by authorised and specialised personnel using a suitable measuring instrument. Please contact the Sigma service department (see chapter 7.3 - "Service contact").

### 3.8 Measures in the event of hazards and accidents



**DANGER**

- If an emergency arises, switch off the centrifuge immediately!
- If in doubt, call the emergency doctor!

### 3.9 Remaining hazards

The centrifuge was built in accordance with the state of the art and in compliance with the generally recognized safety rules. However, danger to life and limb of the operator, or of third parties, or impairments of the unit or other material assets cannot be completely excluded when the unit is being used.

- Use the unit only for the purpose that it was originally intended for (see chapter 1.2 - "Intended use").
- Use the unit only if it is in a perfect running state.
- Immediately eliminate any problems that can affect safety.

## 4 Storage and transport

### 4.1 Dimensions and weight

	Sigma 1-16, 1-16 IVD
Height:	271 mm
Height with open lid:	527 mm
Width:	310 mm
Depth:	418 mm
Weight:	14 kg

### 4.2 Storage conditions

The centrifuge can be stored in its original packaging for up to a year.

- Store the centrifuge only in dry rooms.
- The permissible storage temperature is between -20°C and +60°C.
- If you would like to store it for more than one year, or if you intend to ship it overseas, please contact the manufacturer.

### 4.3 Notes on transport

- When lifting the centrifuge, always reach under the centrifuge from the side.



**CAUTION**

The centrifuge weighs approx. 14 kg!

- For transport use suitable packaging and, if at all possible, the original packaging (see chapter 4.4 - "Packaging").

## 4 Storage and transport

---

### 4.4 Packaging

The centrifuge is packaged in a cardboard box.

- Open the box.
- Take out the box containing the accessories.
- Lift the centrifuge with both foam cushions out of the cardboard box.  
When lifting the centrifuge, always reach under the centrifuge from the side.



**CAUTION**

The centrifuge weighs approx. 14 kg!

- Retain the packaging for any possible future transport of the centrifuge.

### 4.5 Transport safety device

The centrifuge is not equipped with a transport safety device.



## 5 Set-up and connection

### 5.1 Installation site

Operate the centrifuge only in closed and dry rooms.

All the energy supplied to the centrifuge is converted into heat and emitted to the ambient air.

- Ensure sufficient ventilation.
- Keep a safety distance of at least 30 cm around the centrifuge so that the vents in the centrifuge remain fully effective.
- Do not subject the centrifuge to thermal stress, e.g. by positioning it near heat generators.
- Avoid direct sunlight (UV radiation).
- The table must be stable and have a solid, even surface.
- Attention: During transport from cold to warmer places, condensational water will collect inside the centrifuge. It is important to allow sufficient time for drying (min. 24 h) before the centrifuge can be used again.

### 5.2 Power supply

#### 5.2.1 Type of connection



**DANGER**

The operating voltage on the name plate must correspond to the local supply voltage!

Sigma centrifuges are units of protection class I. The centrifuges of this model series have a three-wire power cord with an IEC C13 connector.

#### 5.2.2 Customer-provided fuses

Typically, the centrifuge must be protected with 16 Amp L or B fuses that are to be provided by the customer.

## 6 Using the centrifuge

---

# 6 Using the centrifuge

## 6.1 Initial start-up



**DANGER**

- Before the initial start-up, please ensure that your centrifuge is properly set up and installed (see chapter 5 - "Set-up and connection").

## 6.2 Switching the centrifuge on

- Press the mains power switch.

The display then illuminates. The centrifuge is ready for operation.

### 6.2.1 Opening and closing the lid

The lid can be opened if the centrifuge is at a standstill.

- Press the lid key in order to open the lid.

The centrifuge cannot be started if the lid is opened.

- To close, press with both hands slightly on the lid until the lid lock is locked.



**WARNING**

Do not place your fingers between the lid and the housing when closing the lid. Risk of crushing!

## 6.2.2 Installation of rotors and accessories

### 6.2.2.1 Installation of a rotor

- 1 Rotor tie down screw
- 2 Motor shaft
- 3 Angle rotor

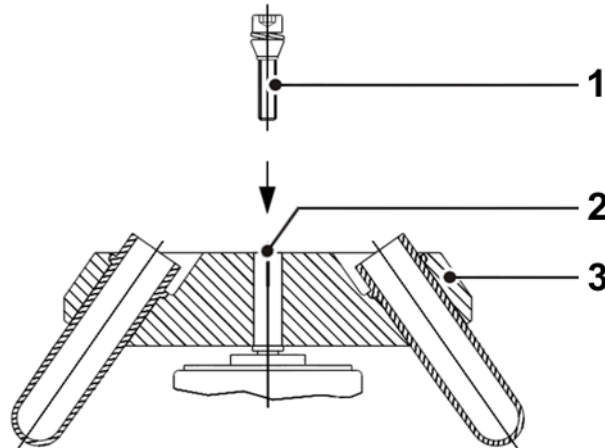

Fig. 5: Installation of an angle rotor

- Open the centrifuge lid by pressing the lid key.
- Loosen the rotor tie-down screw by turning it anti-clockwise, but do not remove it.
- Lower the rotor with its central bore straight down onto the motor shaft.
- Tighten the rotor tie-down screw clockwise with the supplied rotor wrench with 3 Nm. In doing so, hold the rotor at its outer rim.



**WARNING**

Once a day or after 20 cycles, the rotor tie-down screw must be loosened by some turns, and the rotor must be lifted and fastened again. This ensures a proper connection between the rotor and the motor shaft.



**NOTE**

Rotors can be used without a cover. This leads, however, to higher levels of noise and temperatures when running.

- Follow the safety instructions and hazard warnings (see chapter 3 - "Safety")!

## 6 Using the centrifuge

### 6.2.2.2 Installation of a microhaematocrit rotor



Fig. 6: Microhaematocrit rotor (part no. 11024) with reader (part no. 17029)

- Open the centrifuge lid by pressing the lid key.
- Loosen the rotor tie-down screw by turning it anti-clockwise, but do not remove it.
- Lower the rotor with its central bore straight down onto the motor shaft.
- Tighten the rotor tie-down screw clockwise with 3 Nm using the supplied rotor wrench. In doing so, hold the microhaematocrit rotor with one hand and tilt it slightly in order to prevent the motor shaft from slipping through.
- Follow the safety instructions and hazard warnings (see chapter 3 - "Safety")!

#### Operation

- Fill the capillary tubes with blood and seal them at one end with putty or by fusion.
- Place the capillary tubes into the recesses of the rotor with the sealed end against the rubber ring. Ensure that the capillary tubes fit tightly against the rubber ring. The opposite places must be loaded.
- Put the rotor cover on and lock it.
- Close the centrifuge lid.
- Enter the following parameters: speed 14,000 rpm, gravitational field RCF max. 18,626 x g, time approx. 5 min.
- Start the centrifuge.
- Open the centrifuge lid when the rotor has stopped.
- Unlock the rotor cover and lift it off.

#### Evaluation

- Put the reader onto the rotor.
- Turn the reader and perform a fine adjustment with the aid of the central eccentric mechanism in order to localize the O-point and the maximum liquid point in the capillary tubes. You can now read the percentage value.
- Remove the capillary tubes. Some of the tubes can also be evaluated with the reader outside of the rotor (see the instructions for use on the back of the reader).

**6.2.2.3 Installation of accessories**

- Only use tubes that are suitable for the rotor.
- Always load the axial symmetrical inserts of the rotors with the same accessories and fill to avoid imbalance.

**Centrifugation with low capacity**

- Install the tubes axial symmetrical so that the rotor is loaded evenly.
- It is not permissible to load angle rotors on only one axis.

correct

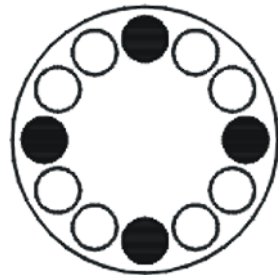

incorrect

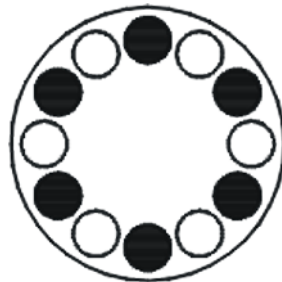
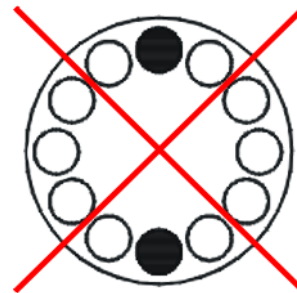

*Fig. 7: Permissible and impermissible loading of an angle rotor (example illustration)*

**6.2.2.4 Vessels**

- Load the vessels outside of the centrifuge. Liquids in the bores of the rotor cause corrosion.
- Fill the vessels carefully and arrange them according to their weight. Imbalances result in the excessive wear of the bearings.
- Follow the safety instructions and hazard warnings (see chapter 3 - "Safety")!

## 6 Using the centrifuge

### 6.3 Control System "Spincontrol Basic"

#### 6.3.1 User interface

- 1 Display
- 2 Set key
- 3 Program key
- 4 Arrow keys
- 5 Lid key
- 6 Start/Stop key
- 7 Quick run key



Fig. 8: User interface

The centrifuge is started directly via the user interface. When the centrifuge is switched on, all segments will be illuminated for a short time. It is now ready for operation.

#### 6.3.2 Display

The centrifuge display has the following display fields:

- 1 Field for deceleration curves, run mode, and programs
- 2 Speed / RCF field
- 3 Time field
- 4 Field for rotor selection

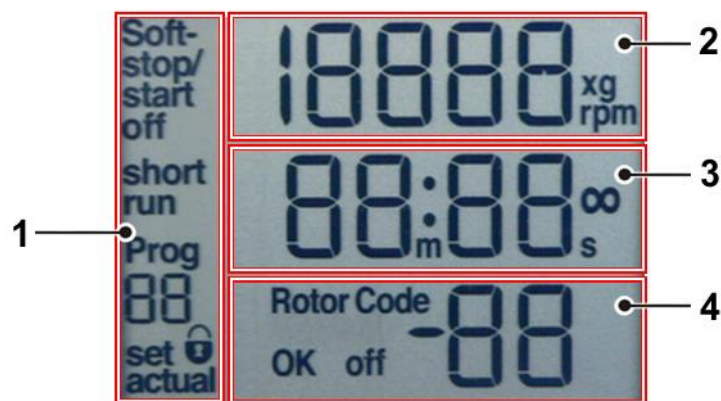

Fig. 9: Display, completely illuminated

### **6.3.3 Starting a centrifugation run**

The centrifuge is ready for operation when the mains power switch is on and the lid is closed.

- Press the start/stop key in order to start a centrifugation run.

### **6.3.4 Interrupting a centrifugation run**

- Press the start/stop key in order to interrupt a centrifugation run. The centrifugation run will be terminated prematurely.

### **6.3.5 Interrupting a deceleration process**

- Press the start/stop key during a deceleration process in order to interrupt it and to restart the centrifuge.

### **6.3.6 Speed / Relative centrifugal force (RCF)**

The RCF value is determined by the rotor geometry and speed. The RCF and speed values, therefore, depend on each other. If one of the two values is entered, the other value will be set automatically.

- To preselect a speed value or a RCF value, press the set key repeatedly until the corresponding unit flashes on the display.
- Select the desired speed or RCF value via the arrow keys.
- Confirm the selection by pressing the start/stop key.

The data will also be accepted and saved after approx. 20 seconds if no other key is pressed within this time period.

During operation, you can switch from the speed value to the RCF value and vice versa via the arrow keys.

#### **6.3.6.1 Changing the speed/RCF value during centrifugation**

The preselected speed or RCF value can be changed during centrifugation.

- Press the set key repeatedly until the desired unit flashes on the display.
- Change the speed or RCF value by pressing the arrow keys. The parameters will take effect immediately.

## 6 Using the centrifuge

---

### 6.3.7 Runtime

The preselected total runtime is displayed in the lower line of the display. During centrifugation, the remaining runtime is displayed. The runtime of the centrifuge can be set at one-second-intervals up to 99 minutes and 59 seconds.

- To select a runtime, press the set key repeatedly until the time unit flashes on the display.
- Select the desired runtime by pressing the arrow keys.
- Confirm the selection by pressing the start/stop key.

The data will also be accepted and saved after approx. 20 seconds if no other key is pressed within this time period.

#### 6.3.7.1 Changing the runtime during centrifugation

The preselected runtime can be changed during centrifugation.

- Press the "set" key repeatedly until the time unit flashes on the display.
- Change the desired runtime by pressing the arrow keys. The parameters will be accepted immediately.



#### NOTE

If the centrifugation time is changed during the run, the centrifuge will run for the entire new time and will disregard the previous runtime that has already elapsed.

#### 6.3.7.2 Short run

During the short run, the centrifuge accelerates at maximum power until the maximum speed is reached.

- Keep the quick run key pressed during the short run.

The message "short run" and the duration of the short run are displayed. When the quick run key is released, the centrifuge decelerates at maximum power to a standstill.

After the short run, the lid unlocks automatically and the program that was set beforehand is displayed again.



### 6.3.7.3 Continuous run

During the continuous run, the runtime of the centrifuge is unlimited and must be stopped manually. The centrifuge accelerates during the continuous run until the set speed is reached.

- To start the continuous run, press the set key until the time unit flashes on the display.
- Press the down-key (arrow key) until the display switches from "00:10" to "--:--".

After 99 min 59 sec, any additional runtime will no longer be displayed, but the centrifugation will continue.

- To stop a continuous run, press the start/stop key. The centrifugation will end.
- Enter a runtime. The centrifugation will end after this time.

### 6.3.8 Softstart and softstop function

The softstart function is used to extend the acceleration time, whereas the softstop function is used to extend the deceleration time. The current combination is shown on the display.

- To activate the softstart and softstop functions, press the set key repeatedly until "Soft-stop/start" flashes in the upper left part of the display.
- Press the arrow keys until "Soft-stop/start on" is displayed. The softstart and softstop functions are now activated.
- Press the arrow key until "Soft stop on" is displayed. Only the softstop function will be active and the centrifuge will start at normal speed.
- Press the arrow key until "Soft off" is displayed. The softstart and softstop functions are now deactivated.

The data will be accepted immediately and saved after approx. 20 seconds. You can also change the settings as described above during a centrifugation run.

## 6 Using the centrifuge

### 6.3.9 Rotor selection

In the delivery status of the centrifuge, the rotor 12134 is preselected. If another rotor is installed the configuration must be changed, so that the allowed maximum speed of the rotor can be reached.

- To select another rotor, press the set key and hold it for approx. 2 seconds.
- Choose the number of the installed rotor out of the following list, by pressing the arrow keys:

<b>Code</b>	1	2	3	4	5
<b>Rotor</b>	11024	12024	12134	12135	12136
<b>Code</b>	6	7	8	9	10
<b>Rotor</b>	12137	12180	--	--	--

- Press the set key to confirm the input.

The RCF value will be adjusted automatically to the selected rotor.



#### NOTE

The rotor selection will be saved under the corresponding program number.

### 6.3.10 Programs

Programs are used to save or load certain recurrent settings of the centrifuge. 10 different programs can be saved and called up.

#### 6.3.10.1 Saving the current settings

- Press the program key. Then, select a program number by pressing the arrow keys. The display "Prog - -" will now flash.
- Select the correct rotor.
- Press the set key repeatedly until the corresponding unit flashes on the display. Select the desired parameters.
- In order to save the data, start the centrifuge or press the set key repeatedly until the indication "Prog - -" stops flashing.



#### NOTE

Program numbers that are already occupied will be overwritten with the current data.

#### 6.3.10.2 Calling up stored programs

- Press the program key. Then, select a program number by pressing the arrow keys. The display "Prog - -" will now flash.
- Ensure that the correct rotor is installed.
- In order to save the data, start the centrifuge or press the set key repeatedly until the indication "Prog - -" stops flashing.

### 6.4 Switching the centrifuge off

- Open the centrifuge when it is not in use so that moisture can evaporate.
- Switch the centrifuge off by pressing the mains power switch.

## 7 Malfunctions and error correction

# 7 Malfunctions and error correction

## 7.1 General malfunctions

Malfunctions are indicated by error messages with a number in the speed/RCF display.

In the event of a fatal error (e.g. a defective lid lock), a certain safety time will be counted down on the display. During this time, "ERR" and "SAFE" flash alternately on the display. When the time is up, "OFF" will be displayed.



**WARNING**

Do not switch the centrifuge off until "OFF" is displayed! This is necessary in order to ensure that the rotor is at a complete standstill.

- Eliminate the source of the problem (see tables below).
- Acknowledge the error messages with the lid key.

Type of error	Possible reason	Correction
No indication on the display	No power in the mains supply	Check fuse in the mains supply
	Power cord is not plugged in	Plug in power cord correctly
	Mains power switch off	Switch mains power switch on
	Lid is not closed correctly	Close the lid
Centrifuge cannot be started: The set speed value is displayed in an unchanged manner	Several possible causes	Netz aus/ein. Falls sich der Fehler wiederholt, Service verständigen
	The lid lock is not closed correctly	Open and close lid. If the error occurs again, contact service
Centrifuge decelerates during operation and displays an error from 1 to 18 after powering on	Several possible causes	Power off/on. If the error occurs again, contact service
Centrifuge decelerates during operation and displays error 19 after powering on	Several possible causes	Acknowledge by pressing the lid key
Lid cannot be opened	Lid locks have not released	Unlock the lid manually (see chapter 7.1.1 - "Emergency lid release") and contact service
	Lid seal sticks	Clean the lid seal and apply talcum powder
Temperature value cannot be reached (only for refrigerated centrifuges)	Condenser dirty	Contact service

### 7.1.1 Emergency lid release

In the event of a power failure, it is possible to manually open the centrifuge lid.

- Switch off the mains power switch and disconnect the power cord from the socket.
- Remove the plug (see figure, item 1) from the opening on the left side of the control panel, e.g. with a screwdriver.



Fig. 10: Position of the opening for the emergency lid release

- Insert the supplied hexagon socket key horizontally into the hole and turn it anti-clockwise to the stop. The lid lock will then audibly unlock.



Fig. 11: Manual release of the lid lock

- Then, reinsert the plug.



**WARNING**

Do not unlock or open the lid unless the rotor is at a standstill.

If the lid is opened via the emergency lid release system during a centrifuge run, the centrifuge will be switched off immediately and decelerate in an unbraked manner.

## 7 Malfunctions and error correction

### 7.2 Table of error codes

Error no.	Kind of error	Measures	Note
1-9	System error	<ul style="list-style-type: none"> <li>Allow to slow down</li> <li>Power off/on</li> </ul>	All these errors stop the centrifuge or cause it to decelerate brakeless
10-19	Speedometer error	<ul style="list-style-type: none"> <li>Allow to slow down</li> <li>Power off/on</li> </ul>	
20-29	Motor error	<ul style="list-style-type: none"> <li>Power off</li> <li>Ensure ventilation</li> </ul>	
30-39	EEPROM error	<ul style="list-style-type: none"> <li>Allow to slow down</li> <li>Power off/on</li> </ul>	With error 34, 35, and 36, the centrifuge will stop; with error 37 and 38 only an error message will be given
40-45	Temperature error (only for refrigerated centrifuges)	<ul style="list-style-type: none"> <li>Allow to slow down</li> <li>Power off</li> <li>Allow to cool down</li> <li>Provide better ventilation (only air cooled centrifuges)</li> <li>Provide sufficient water throughput (only water cooled centrifuges)</li> </ul>	
46-49	Imbalance error (only for centrifuges with imbalance monitoring system)	<ul style="list-style-type: none"> <li>Allow to slow down</li> <li>Power off</li> <li>Eliminate the imbalance</li> </ul>	
50-59	Lid error	<ul style="list-style-type: none"> <li>Press lid key</li> <li>Close lid</li> <li>Remove foreign matter from the opening of the lid lock device</li> </ul>	With error 50 and 51, the centrifuge will stop
60-69	Process error	<ul style="list-style-type: none"> <li>Allow to slow down</li> <li>Power off/on</li> </ul>	With error 60, the message "power failure during run" will be displayed, with error 61, the message "stop after power on" will be displayed
70-79	Communication error	<ul style="list-style-type: none"> <li>Allow to slow down</li> <li>Power off/on</li> </ul>	
80-89	Parameter error	<ul style="list-style-type: none"> <li>Power off</li> <li>Allow to cool down</li> <li>Provide for better ventilation</li> </ul>	With error 83, error message only
90-99	Other errors	<ul style="list-style-type: none"> <li>Check connections</li> <li>Provide sufficient water throughput (only water cooled centrifuges)</li> </ul>	



#### NOTE

If it is impossible to eliminate the errors, contact the service!

### 7.3 Service contact

In the event of queries, malfunctions, or spare part enquiries:

**From Germany:**

Contact

Sigma Laborzentrifugen GmbH  
An der Unteren Söse 50  
37520 Osterode (Germany)  
Tel. +49 (0) 55 22 / 50 07-44 44  
E-mail: support.lab@sigma-zentrifugen.de

**Outside Germany:**

Contact our agency in your country. All agencies are listed at  
[www.sigma-zentrifugen.de](http://www.sigma-zentrifugen.de) → [Sales Partners]



**NOTE**

- If you would like to utilise our service, please state the type of your centrifuge and its serial number.

## 8 Maintenance and service

### 8 Maintenance and service

The centrifuge, rotor, and accessories are subject to high mechanical stress. Thorough maintenance performed by the user extends the service life and prevents premature failure.



#### CAUTION

If corrosion or other damage occurs due to improper care, the manufacturer cannot be held liable or subject to any warranty claims.

- Use soap water or other water-soluble, mild cleaning agents with a pH value between 6 and 8 for cleaning the centrifuge and accessories (see also chapter 8.2 - "Sterilisation and disinfection of the rotor chamber and accessories").
- Avoid corrosive and aggressive substances.
- Do not use solvents.
- Do not use agents with abrasive particles.
- Do not expose the centrifuge and rotors to intensive UV radiation or thermal stress (e.g. by heat generators).

#### 8.1 Maintenance

##### 8.1.1 Centrifuge

- Unplug the mains power plug before cleaning.
- Carefully remove all liquids, including water and particularly all the solvents, acids, and alkaline solutions from the rotor chamber using a cloth in order to avoid damage to the motor bearings.
- If the centrifuge has been contaminated with toxic, radioactive, or pathogenic substances, clean the rotor chamber immediately with a suitable decontamination agent (depending on the type of contamination).



#### WARNING

Take suitable precautions for your own safety if there is a risk of toxic, radioactive, or pathogenic contamination.

- After every cleaning process, grease the motor shaft slightly with a small amount of heavy-duty grease for load-bearing bolts (part no. 71401) and distribute the grease with a cloth so that it forms a thin layer.



### 8.1.2 Accessories



**CAUTION**

For the care of the accessories, special safety measures must be considered as these are measures that will ensure operational safety at the same time!

- Immediately rinse off the rotor, buckets, or accessories under running water if they have come into contact with any liquids that may cause corrosion. Use a brush for test tubes in order to clean the bores of angle rotors. Turn the rotor upside down and allow it to dry completely.
- Clean the accessories outside the centrifuge once a week or preferably after each use. Adapters should be removed, cleaned and dried.



**CAUTION**

#### **Do not clean the accessories in a dishwasher!**

Cleaning in a dishwasher removes the anodised coating; the result is cracking in areas that are subject to stress.

- If the rotors or accessories have been contaminated with toxic, radioactive, or pathogenic substances, clean them immediately with a suitable decontamination agent (depending on the type of contamination). Take suitable precautions for your own safety if there is a risk of toxic, radioactive, or pathogenic contamination.
- Dry the accessories with a soft cloth or in a drying chamber at approx. 50°C.

#### 8.1.2.1 Plastic accessories

The chemical resistance of plastic decreases with rising temperatures (see chapter 11.4 - "Resistance data").

- If solvents, acids, or alkaline solutions have been used, clean the plastic accessories thoroughly.



**WARNING**

Plastic accessories must not be greased!

## 8 Maintenance and service

---

### 8.1.3 Rotors

The rotors are produced with the highest precision, in order to withstand the permanent high stress from high gravitational fields.

Chemical reactions as well as stress-corrosion (combination of oscillating pressure and chemical reaction) can affect or destroy the metals. Barely detectable cracks on the surface can expand and weaken the material without any visible signs.

- Check the material regularly (at least once a month) for
  - cracks
  - visible damage of the surface
  - pressure marks
  - signs of corrosion
  - other changes.
- Check the bores of the rotors and multiple carriers.
- Replace any damaged components immediately for your own safety.

### 8.1.4 Microhaematocrit rotor

- Remove the microhaematocrit rotor for cleaning.
- Wipe the centrifuge chamber clean.
- Replace the rubber ring in the event of wear or glass breakage (part no. 16003 for rotor 11024).

### 8.1.5 Glass breakage



#### CAUTION

In the case of glass breakage, immediately remove all glass particles (e.g. with a vacuum cleaner). Replace the rubber cushions since even thorough cleaning will not remove all glass particles.

Glass particles will damage the surface coating (e.g. anodising) of the buckets, which will then lead to corrosion.

Glass particles in the rubber cushions of the buckets will cause glass breakage again.

Glass particles on the pivot bearing of the load-bearing bolts prevent the buckets and carriers from swinging evenly, which will cause an imbalance.

Glass particles in the rotor chamber will cause metal abrasion due to the strong air circulation. This metal dust will not only pollute the rotor chamber, rotor, and materials to be centrifuged but also damage the surfaces of the accessories, rotors, and rotor chamber.

**In order to completely remove the glass particles and metal dust from the rotor chamber:**

- Grease the upper third of the rotor chamber with e.g. Vaseline.
- Then, let the rotor rotate for a few minutes at a moderate speed (approx. 2000 rpm). The glass and metal particles will now collect at the greased part.
- Remove the grease with the glass and metal particles with a cloth.
- If necessary, repeat this procedure.

## **8.2 Sterilisation and disinfection of the rotor chamber and accessories**

- Use commercially-available disinfectants such as, for example, Sagrotan<sup>®</sup>, Buraton<sup>®</sup>, or Terralin<sup>®</sup> (available at chemist's shops or drugstores).
- The centrifuge and the accessories consist of various materials. A possible incompatibility must be considered.
- Before using cleaning or decontamination agents that were not recommended by us, contact the manufacturer to ensure that such a procedure will not damage the centrifuge.
- For autoclaving, consider the continuous heat resistance of the individual materials (see chapter 8.2.1 - "Autoclaving").

Please contact us if you have any queries (see chapter 7.3 - "Service contact").



**DANGER**

If dangerous materials (e.g. infectious and pathogenic substances) are used, the centrifuge and accessories must be disinfected.

## 8 Maintenance and service

### 8.2.1 Autoclaving

The service life of the accessories essentially depends on the frequency of autoclaving and use.

- Replace the accessories immediately when the parts show changes in colour or structure or in the occurrence of leaks etc.
- During autoclaving, the caps of the tubes must not be screwed on in order to avoid the deformation of the tubes.



#### NOTE

It cannot be excluded that plastic parts, e.g. lids or carriers, may deform during autoclaving.

Accessories	Max. temp. (°C)	Min. time (min)	Max. time (min)	Max. cycles
Aluminium buckets	134-138	3	5	-
Aluminium rotors	134-138	3	5	-
Glass tubes	134-138	3	40	-
Polyallomer / polycarbonate rectangular carriers	115-118	30	40	-
Polyallomer / polycarbonate round carriers	115-118	30	40	-
Polyamide buckets	115-118	30	40	10
Polycarbonate / polyallomer lids for angle rotors	115-118	30	40	20
Polycarbonate tubes	115-118	30	40	20
Polyphenylsulfone (PPSU) caps for buckets	134-138	3	5	100
Polypropylene balance adapter for blood-bag systems	115-118	30	40	n.s.
Polypropylene copolymer tubes	115-121	30	40	20
Polypropylene rectangular carriers	115-118	30	40	-
Polypropylene rotors	115-118	30	40	20
Polypropylene round carriers	115-118	30	40	-
Polysulfone caps for buckets	134-138	3	5	100
Polysulfone lids for angle rotors	134-138	3	5	100
Rubber adapters	115-118	30	40	-
Stainless-steel balance weight for blood-bag systems	121	30	30	n.s.
Teflon tubes	134-138	3	5	100

### 8.3 Service



**DANGER**

In the event of service work that requires the removal of the panels, there is a risk of electric shock or mechanical injury. Only qualified specialist personnel is authorised to perform this service work.

The centrifuge is subject to high mechanical stress. In order to be able to withstand this high level of stress, high-quality components were used during the production of the centrifuge. Nevertheless, wear cannot be excluded and it may not be visible from the outside. Especially the rubber parts that are – among other things – part of the motor suspension, are subject to ageing.

This is why we recommend having the centrifuge checked by the manufacturer during an inspection once per year in the operating state and once every three years in the dismantled state. Rubber parts should be replaced after three years.

Information and appointments:

**In Germany:**

Contact

Sigma Laborzentrifugen GmbH

An der Unteren Söse 50

37520 Osterode (Germany)

Tel. +49 (0) 55 22 / 50 07-44 44

E-mail: support.lab@sigma-zentrifugen.de

**Outside Germany:**

Contact our agency in your country. All agencies are listed at [www.sigma-zentrifugen.de](http://www.sigma-zentrifugen.de) → [Sales Partners]



**NOTE**

- If you would like to utilise our service, please state the type of your centrifuge and its serial number.

## 8 Maintenance and service

### 8.4 Return of defective centrifuges or parts

Although we exercise great care during the production of our products, it may be necessary to return a unit or accessory to the manufacturer.

In order to ensure the quick and economical processing of returns of centrifuges, spare parts, or accessories, we require complete and extensive information concerning the process. Please fill in the following forms completely, sign them, enclose them with the return package, and send them together with the product to:

Sigma Laborzentrifugen GmbH  
An der Unteren Söse 50  
37520 Osterode (Germany)

#### 1. Declaration of decontamination

As a certified company and due to the legal regulations for the protection of our employees and of the environment, we are obliged to certify the harmlessness of all incoming goods. For this purpose, we require a declaration of decontamination.

- The form must be filled in completely and signed by authorised and specialised personnel only.
- Affix the original form in a clearly visible manner to the outside of the packaging.



#### NOTE

We will return the part/unit if no declaration of decontamination is provided!

#### 2. Form for the return of defective parts

This form is for the product-related data. They facilitate the assignment, and they enable the quick processing of the return. If several parts are returned together in one packaging, please enclose a separate problem description for every defective part.

- A detailed problem description is necessary in order to perform the repair quickly and economically.



#### NOTE

If the form does not include a description of the malfunction, neither a refund nor a credit note can be issued. In this case, we reserve the right to return the part/unit to you at your expense.

- Upon request, we will prepare and submit to you a cost estimate prior to performing the repair. Please confirm such cost estimate within 14 days. If the cost estimate has still not been confirmed after 4 weeks, we will return the defective part/unit. Please note that you must bear the incurred costs.



The defective part/unit must be packaged in a transport-safe manner. Please use the original packaging for the unit, if at all possible. If the product is dispatched to us in unsuitable packaging, you will be charged the cost for returning it to you in new packaging.

The forms can be downloaded online from  
[www.sigma-zentrifugen.de](http://www.sigma-zentrifugen.de) → [Service] → [Overhaul and repair].

## 9 Disposal

---

### 9 Disposal

#### 9.1 Disposal of the centrifuge



In accordance with the directive 2002/96/EC, SIGMA centrifuges are marked with the symbol shown to the left. This symbol means that it is not permissible to dispose of the unit among household waste.

- You can return these centrifuges free of cost to Sigma Laborzentrifugen GmbH.
- Ensure that the unit is decontaminated. Fill in a declaration of decontamination (see chapter 8.4 - "Return of defective centrifuges or parts").
- Comply with any other applicable local rules and regulations.

#### 9.2 Disposal of the packaging

- Use the packaging to return the centrifuge for disposal or
- dispose of the packaging, after having separated the individual materials.
- Comply with all local rules and regulations.



## 10 Technical data

<b>Manufacturer:</b>	<b>Sigma Laborzentrifugen GmbH An der Unteren Söse 50 37520 Osterode Sigma</b>	
Type:	1-16	1-16 IVD
Order no.:	10025, 10026, 10027	10035, 10036, 10037
<u>Connection requirements</u>		
Electrical connection:	see name plate	
Protection class:	I	
IP code:	20	
Connected load (kVA):	0.32 (at 220-240 V / 50-60 Hz) 0.32 (at 120 V / 60 Hz) 0.32 (at 100 V / 50-60 Hz)	
Power consumption (kW):	0.17 (at 220-240 V / 50-60Hz) 0.16 (at 120 V / 60 Hz) 0.17 (at 100 V / 50-60 Hz)	
Max. current consumption (A):	1.40 (at 220-240 V / 50-60Hz) 2.30 (at 120 V / 60 Hz) 2.90 (at 100 V / 50-60 Hz)	
Input fuse (AT):	2.0 (at 220-240 V / 50-60Hz) 4.0 (at 120 V / 60 Hz) 4.0 (at 100 V / 50-60 Hz)	
<u>Performance data</u>		
Max. speed (rpm):	15,000	
Max. capacity (ml):	72	
Max. gravitational field (x g):	16,602	
Max. kinetic energy (Nm):	5,176	
<u>Other parameters</u>		
Time range:	10 sec – 99 min 59 sec, short run, continuous run	
<u>Physical data</u>		
Height (mm):	271	
Height with opened lid (mm):	527	
Width (mm):	310	
Depth (mm):	418	
Weight (kg):	13	
Noise level (dB(A)):	59 (at max. speed)	

## 10 Technical data

<b>Manufacturer:</b>	<b>Sigma Laborzentrifugen GmbH An der Unteren Söse 50 37520 Osterode Sigma</b>	
Type:	1-16	1-16 IVD
Order no.:	10045	10049
<u>Connection requirements</u>		
Electrical connection:	see name plate	
Protection class:	I	
IP code:	20	
Connected load (kVA):	0.21 (at 100-240 V / 50-60 Hz)	
Power consumption (kW):	0.19 (at 100-240 V / 50-60Hz)	
Max. current consumption (A):	2.10 (at 100-240 V / 50-60Hz)	
Input fuse (AF):	6.3 (at 100-240 V / 50-60Hz)	
<u>Performance data</u>		
Max. speed (rpm):	15,000	
Max. capacity (ml):	72	
Max. gravitational field (x g):	16,602	
Max. kinetic energy (Nm):	5,176	
<u>Other parameters</u>		
Time range:	10 sec – 99 min 59 sec, short run, continuous run	
<u>Physical data</u>		
Height (mm):	271	
Height with opened lid (mm):	527	
Width (mm):	310	
Depth (mm):	418	
Weight (kg):	14	
Noise level (dB(A)):	60 (at max. speed)	

### 10.1 Ambient conditions

- The figures are valid for an ambient temperature of +23°C and a nominal voltage  $\pm 10\%$ .



#### NOTE

At a nominal voltage of 100V or 200V, a tolerance of +10% / -5% applies.

- For indoor use only.
- Allowable ambient temperature +5°C to +40°C.
- Max. relative humidity of air 80% up to 31°C with a linear decrease to 50% relative humidity of air at 40°C.
- Maximum altitude 2,000 m above sea level.

## 10.2 Technical documentation

For environmental reasons, the comprehensive technical documentation of the centrifuge (e.g. circuit diagrams) and the safety data sheets of the manufacturers of refrigerants and lubricants are not attached to this documentation.

You can order these documents from our service department.

## 11 Appendix

# 11 Appendix

## 11.1 Range of accessories

The complete list of accessories can be downloaded from [www.sigma-zentrifugen.de](http://www.sigma-zentrifugen.de).

### 11.1.1 Rotor radii

The information in the accessories table concerning the radius refers to the values of the respective rotor as shown below. The radius calculation is described in chapter 2.2.2.1 - "Speed, radius, and relative centrifugal force".

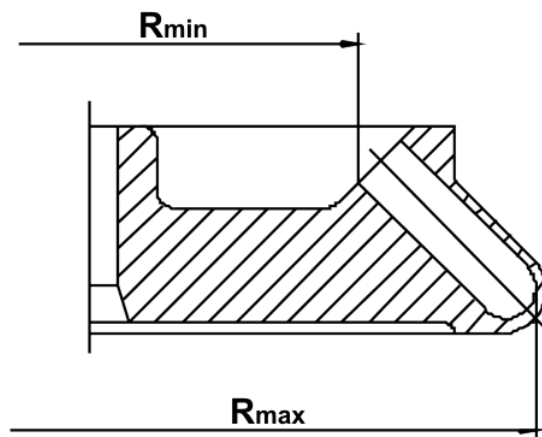

Fig. 12: Minimum and maximum radius of an angle rotor

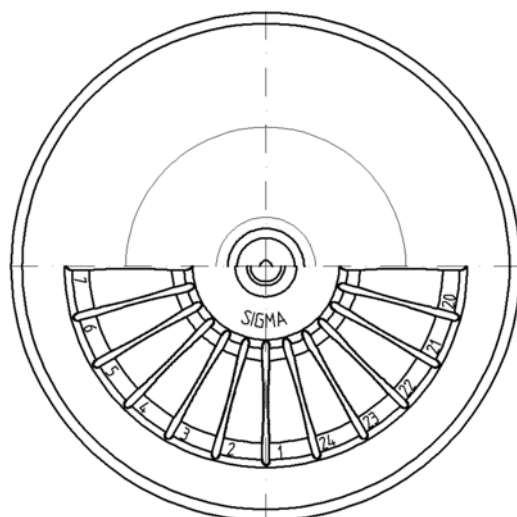

Fig. 13: Microhaematocrit rotor

## 11.2 Speed-gravitational-field-diagram

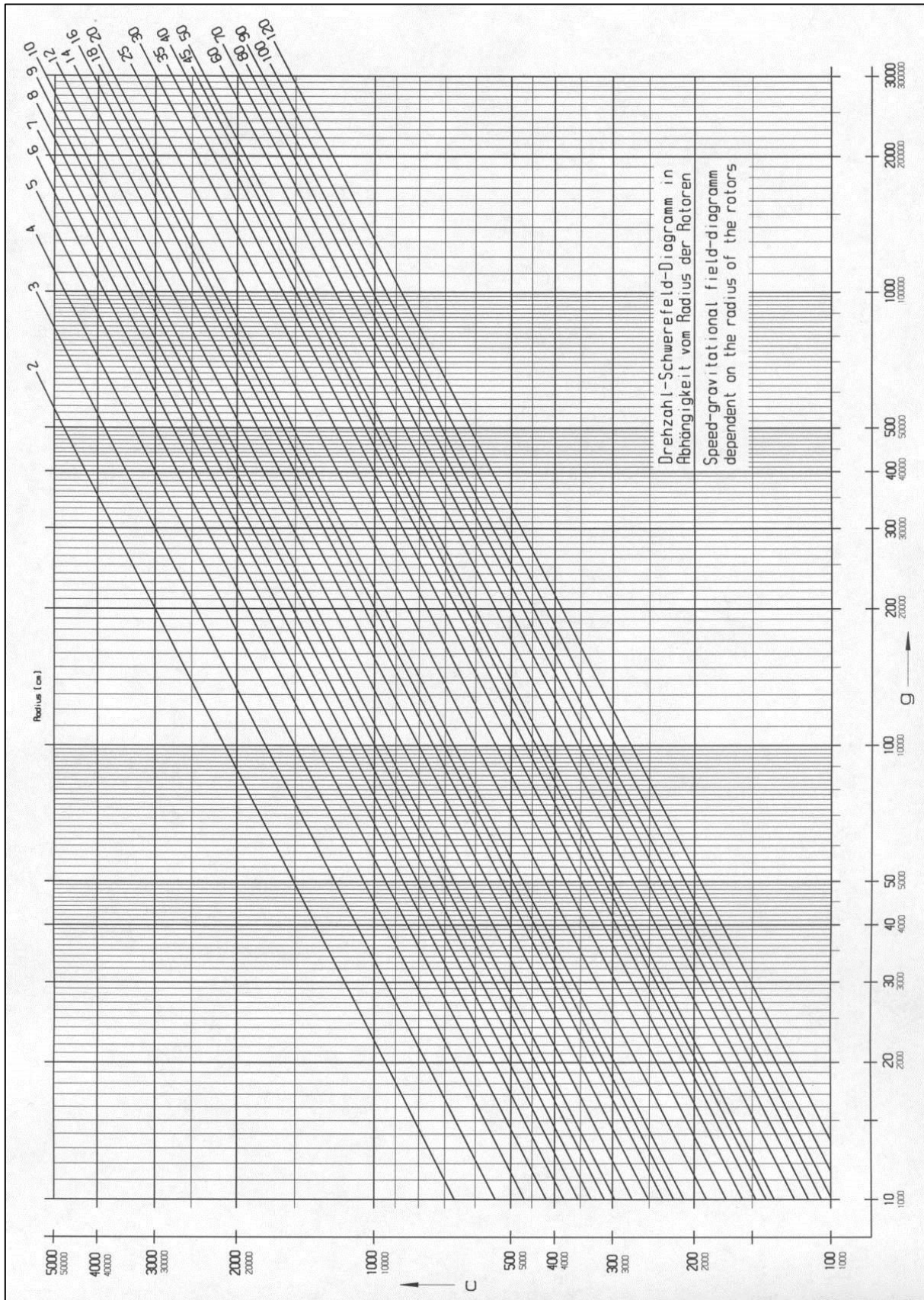

Fig. 14: Speed-gravitational-field-diagram



## 11 Appendix

### 11.3 Table of the service life of rotors and accessories

- If no other data concerning the service life are engraved on the rotor or accessory, rotors and buckets must be checked by the manufacturer after 10 years.
- If a specification concerning the maximum number of cycles **and** a specification concerning the service life (i.e. a date) are provided, the specification that occurs first shall apply.
- After 50,000 cycles, rotors must be scrapped for safety reasons.

Rotor / bucket	Cycles	Service life ("Exp.Date")	Autoclaving	Suitable for centrifuge	Remarks
9100	15,000			4-15C, 4K15C, 4-16, 4-16S, 4-16K, 4-16KS, 6-15, 6K15, 6-16, 6-16K	without engraving, only "spincontrol professional" and "spincontrol S"
11026		7 years		1-14, 1-14K	
11805		10 years*		8K, 8KB, 8KS, 8KBS	*in combination with bucket 13850 or 13860
12033		5 years		1-16 Edition, 1-16K Edition	
12082		7 years		1-14, 1-14K	
12083		7 years		1-14, 1-14K	
12084		7 years		1-14, 1-14K	
12085		7 years		1-14, 1-14K	
12092		5 years	20x	1-14, 1-14K	
12093		5 years	20x	1-14, 1-14K	
12094		5 years	20x	1-14, 1-14K	
12096		5 years	20x	1-14, 1-14K	
12097		5 years	20x	1-14, 1-14K	
12101		5 years	20x	1-15, 1-15K, 1-15P, 1-15PK	
12124		5 years	20x	1-15, 1-15K, 1-15P, 1-15PK	
12126		5 years	20x	1-15, 1-15K, 1-15P, 1-15PK	
12134		5 years	20x	1-16, 1-16K	
12135		5 years	20x	1-16, 1-16K	
12137		5 years	20x	1-16, 1-16K	
12500		7 years		6-15, 6K15, 6-16, 6-16K	
12600		7 years		6-16S, 6-16KS	
13218	20,000			4-16, 4-16S, 4-16K, 4-16KS, 6-16, 6-16S, 6-16K, 6-16KS	
13296	35,000	5 years	10x	2-6, 2-6E, 2-7, 2-16P, 2-16KL, 2-16KHL	
13299		5 years	10x	2-6, 2-6E, 2-7, 2-16P, 2-16KL, 2-16KHL	
13635	25,000			6-16, 6-16K, 6-16S, 6-16KS	
13650	20,000			4-5L, 4-16S, 4-16KS, 4-16KHS, 6-16S, 6-16HS, 6-16KS, 6-16KHS	
13845	20,000			8K, 8KB, 8KS, 8KBS	
13850	10,000	10 years*		8K, 8KB, 8KS, 8KBS	*in combination with rotor 11805
13860	15,000	10 years*		8K, 8KB, 8KS, 8KBS	*in combination with rotor 11805
13864	1,000			8K, 8KB, 8KS, 8KBS	without engraving
13865	1,000			8K, 8KB, 8KS, 8KBS	without engraving
13866	1,000			8K, 8KB, 8KS, 8KBS	without engraving
13867	2,500			8K, 8KB, 8KS, 8KBS	without engraving

## 11.4 Resistance data

**NOTE**

The data refer to resistance at 20°C.

- no data 1 resistant 2 practically resistant 3 partially resistant 4 not resistant	Concentration	High Density Polyethylene	Polyamide	Polycarbonate	Polyoxymethylene	Polypropylene	Polysulfone	Polyvinyl chloride, hard	Polyvinyl chloride, soft	Polytetrafluorethylene	Acrylonitrile-butadiene-caoutchouc	Aluminium	
													Medium
Acetaldehyde	C <sub>2</sub> H <sub>4</sub> O	40	3	2	4	2	3	4	4	-	1	4	1
Acetamide	C <sub>2</sub> H <sub>5</sub> NO	saturated	1	1	4	1	1	4	4	-	1	-	1
Acetone	C <sub>3</sub> H <sub>6</sub> O	100	1	1	4	1	1	4	4	-	1	4	1
Acrylonitrile	C <sub>3</sub> H <sub>3</sub> N	100	1	1	4	3	3	4	4	4	1	4	1
Allyl alcohol	C <sub>3</sub> H <sub>6</sub> O	96	1	3	3	2	2	2	2	4	1	1	1
Aluminium chloride	AlCl <sub>3</sub>	saturated	1	3	2	4	1	-	1	-	1	1	4
Aluminium sulfate	Al <sub>2</sub> (SO <sub>4</sub> ) <sub>3</sub>	10	1	1	1	3	1	1	1	1	1	1	1
Ammonium chloride	(NH <sub>4</sub> )Cl	aqueous	1	1	1	2	1	1	1	1	1	1	3
Ammonium hydroxide	NH <sub>3</sub> + H <sub>2</sub> O	30	1	3	4	1	1	2	1	-	1	-	1
Aniline	C <sub>6</sub> H <sub>7</sub> N	100	1	3	4	1	2	4	4	4	1	4	1
Anisole	C <sub>7</sub> H <sub>8</sub> O	100	3	4	4	1	4	4	2	-	1	4	1
Antimony trichloride	SbCl <sub>3</sub>	90	1	4	1	4	1	-	1	-	1	-	4
Benzaldehyde	C <sub>7</sub> H <sub>6</sub> O	100	1	3	4	1	1	3	4	4	1	4	1
Benzene	C <sub>6</sub> H <sub>6</sub>	100	3	2	4	1	3	4	4	-	1	4	1
Boric acid	H <sub>3</sub> BO <sub>3</sub>	aqueous	1	3	1	2	1	-	-	-	1	1	1
Butyl acrylate	C <sub>7</sub> H <sub>12</sub> O <sub>2</sub>	100	1	2	4	2	3	4	4	4	1	-	1
Butyl alcohol, normal	C <sub>4</sub> H <sub>10</sub> O	100	1	1	2	1	1	2	2	4	1	1	1
Calcium chloride	CaCl <sub>2</sub>	alcoholic	1	4	2	3	1	-	-	4	1	1	3
Carbon disulfide	CS <sub>2</sub>	100	4	3	4	2	4	4	4	4	1	3	1
Carbon tetrachloride (TETRA)	CCl <sub>4</sub>	100	4	4	4	2	4	4	4	4	1	3	1
Chlorine	Cl <sub>2</sub>	100	4	4	4	4	4	4	4	4	1	-	3
Chlorine water	Cl <sub>2</sub> x H <sub>2</sub> O		3	4	4	4	3	-	3	3	1	-	4
Chlorobenzene	C <sub>6</sub> H <sub>5</sub> Cl	100	3	4	4	1	3	4	4	4	1	4	1
Chloroform	CHCl <sub>3</sub>	100	3	3	4	4	3	4	4	4	1	4	3

## 11 Appendix

- no data 1 resistant 2 practically resistant 3 partially resistant 4 not resistant	Medium	Formula	Concentration [%]	High Density Polyethylene	Polyamide	Polycarbonate	Polyoxymethylene	Polypropylene	Polysulfone	Polyvinyl chloride, hard	Polyvinyl chloride, soft	Polytetrafluorethylene	Acrylonitrile-butadiene- caoutchouc	Aluminium
				HDPE	PA	PC	POM	PP	PSU	PVC	PVC	PTFE	NBR	AL
	Chromic acid	CrO <sub>3</sub>	10	1	4	2	4	1	4	1	-	1	4	1
	Chromic potassium sulphate	KCr(SO <sub>4</sub> ) <sub>2</sub> x 12H <sub>2</sub> O	saturated	1	2	1	3	1	-	1	-	1	-	3
	Citric acid	C <sub>6</sub> H <sub>8</sub> O <sub>7</sub>	10	1	1	1	2	1	1	1	1	1	1	1
	Citric acid	C <sub>6</sub> H <sub>8</sub> O <sub>7</sub>	50	1	3	1	2	1	-	-	-	1	1	1
	Copper sulphate	CuSO <sub>4</sub> x 5H <sub>2</sub> O	10	1	1	1	1	1	1	1	1	1	1	4
	Cyclohexanol	C <sub>6</sub> H <sub>12</sub> O	100	1	1	3	1	1	1	1	4	1	2	1
	Decane	C <sub>10</sub> H <sub>22</sub>	100	-	1	2	1	3	-	-	-	1	2	1
	Diaminoethane	C <sub>2</sub> H <sub>8</sub> N <sub>2</sub>	100	1	1	3	1	1	-	3	4	1	1	1
	Diesel fuel	—	100	1	1	3	1	1	-	1	3	1	1	1
	Dimethyl formamide (DMF)	C <sub>3</sub> D <sub>7</sub> NO	100	1	1	4	1	1	4	3	-	1	3	1
	Dimethyl sulfoxide (DMSO)	C <sub>2</sub> H <sub>6</sub> SO	100	1	2	4	1	1	4	4	-	1	-	1
	Dimethylaniline	C <sub>8</sub> H <sub>11</sub> N	100	-	3	4	2	4	-	-	-	1	-	1
	Dioxane	C <sub>4</sub> H <sub>8</sub> O <sub>2</sub>	100	2	1	4	1	3	2	3	4	1	3	1
	Dipropylene glycol (mono)methyl ether	C <sub>4</sub> H <sub>10</sub> O	100	3	1	4	1	4	4	4	4	1	-	1
	Ethyl acetate	C <sub>4</sub> H <sub>8</sub> O <sub>2</sub>	100	1	1	4	1	1	4	4	4	1	4	1
	Ethylene chloride	C <sub>2</sub> H <sub>4</sub> Cl <sub>2</sub>	100	3	3	4	1	3	4	4	4	1	-	1
	Ferrous chloride	FeCl <sub>2</sub>	saturated	1	3	1	3	1	1	1	1	1	-	4
	Formaldehyde solution	CH <sub>2</sub> O	30	1	3	1	1	1	-	-	-	1	2	1
	Formic acid	CH <sub>2</sub> O <sub>2</sub>	100	1	4	3	4	1	3	3	1	1	2	1
	Furfural	C <sub>5</sub> H <sub>4</sub> O <sub>2</sub>	100	1	3	3	2	4	-	-	-	1	4	1
	Gasoline	C <sub>5</sub> H <sub>12</sub> - C <sub>12</sub> H <sub>26</sub>	100	2	1	3	1	3	3	2	-	1	1	1
	Glycerol	C <sub>3</sub> H <sub>8</sub> O <sub>3</sub>	100	1	1	3	1	1	1	1	2	1	1	1
	Heptane, normal	C <sub>7</sub> H <sub>16</sub>	100	2	1	1	1	2	1	2	4	1	1	1
	Hexane, n-	C <sub>6</sub> H <sub>14</sub>	100	2	1	2	1	2	1	2	4	1	1	1
	Hydrogen chloride	HCl	5	1	4	1	4	1	1	1	-	1	2	4
	Hydrogen chloride	HCl	concentrated	1	4	4	4	1	1	2	3	1	4	4
	Hydrogen peroxide	H <sub>2</sub> O <sub>2</sub>	3	1	3	1	1	1	1	1	-	1	3	3
	Hydrogen peroxide	H <sub>2</sub> O <sub>2</sub>	30	1	4	1	4	1	1	1	-	1	3	3
	Hydrogen sulphide	H <sub>2</sub> S	10	1	1	1	1	1	1	1	3	1	3	1
	Iodine, tincture of	I <sub>2</sub>		1	4	3	1	1	-	4	4	1	1	1



**11 Appendix**

- no data 1 resistant 2 practically resistant 3 partially resistant 4 not resistant	Medium	Formula	Concentration [%]	High Density Polyethylene	Polyamide	Polycarbonate	Polyoxymethylene	Polypropylene	Polysulfone	Polyvinyl chloride, hard	Polyvinyl chloride, soft	Polytetrafluorethylene	Acrylonitrile-butadiene- caoutchouc	Aluminium
				HDPE	PA	PC	POM	PP	PSU	PVC	PVC	PTFE	NBR	AL
	Isopropyl alcohol	C <sub>3</sub> H <sub>8</sub> O	100	1	1	1	1	1	1	1	4	1	-	2
	Lactic acid	C <sub>3</sub> H <sub>6</sub> O <sub>3</sub>	3	1	3	1	2	1	1	2	-	1	1	1
	Magnesium chloride	MgCl <sub>2</sub>	10	1	1	1	1	1	1	1	1	1	1	1
	Mercuric chloride	HgCl <sub>2</sub>	10	1	4	1	3	1	1	1	1	1	1	4
	Mercury	Hg	100	1	1	1	1	1	1	1	3	1	1	3
	Methyl acetate	C <sub>3</sub> H <sub>6</sub> O <sub>2</sub>	100	1	1	4	2	1	-	4	4	1	-	1
	Methyl alcohol	CH <sub>4</sub> O	100	1	2	4	1	1	3	1	3	1	2	1
	Methyl benzene	C <sub>7</sub> H <sub>8</sub>	100	3	1	4	1	3	4	4	4	1	4	1
	Methyl ethyl ketone (MEK)	C <sub>4</sub> H <sub>8</sub> O	100	1	1	4	1	1	4	4	4	1	4	1
	Methylene chloride	CH <sub>2</sub> Cl <sub>2</sub>	100	4	3	4	3	3	4	4	4	1	-	1
	Mineral oil	—	100	1	1	1	1	1	1	1	-	1	1	1
	Nitric acid	HNO <sub>3</sub>	10	1	4	1	4	1	1	1	-	1	4	3
	Nitric acid	HNO <sub>3</sub>	100	4	4	4	4	4	-	4	-	1	4	1
	Nitrobenzene	C <sub>6</sub> H <sub>5</sub> NO <sub>2</sub>	100	3	4	4	3	2	4	4	4	1	4	1
	Oleic acid	C <sub>18</sub> H <sub>34</sub> O <sub>2</sub>	100	1	1	1	2	1	-	1	-	1	3	1
	Oxalic acid	C <sub>2</sub> H <sub>2</sub> O <sub>4</sub> x 2H <sub>2</sub> O	100	1	3	1	4	1	1	1	1	1	2	1
	Ozone	O <sub>3</sub>	100	3	4	1	4	3	1	1	-	1	4	2
	Petroleum	—	100	1	1	3	1	1	1	1	3	1	1	1
	Phenol	C <sub>6</sub> H <sub>6</sub> O	10	1	4	4	4	1	4	1	3	1	3	1
	Phenol	C <sub>6</sub> H <sub>6</sub> O	100	2	4	4	4	1	3	4	3	1	3	1
	Phosphoric acid	H <sub>3</sub> PO <sub>4</sub>	20	1	4	2	4	1	-	-	-	1	2	4
	Phosphorus pentachloride	PCl <sub>5</sub>	100	-	4	4	4	1	-	4	4	1	-	1
	Potassium hydrogen carbonate	CHKO <sub>3</sub>	saturated	1	1	2	1	1	-	-	-	1	-	4
	Potassium hydroxide	KOH	30	1	1	4	3	1	1	1	1	1	-	4
	Potassium hydroxide	KOH	50	1	1	4	3	1	1	1	1	1	-	4
	Potassium nitrate	KNO <sub>3</sub>	10	1	1	1	1	1	-	-	-	1	1	1
	Potassium permanganate	KMnO <sub>4</sub>	100	1	4	1	1	1	-	1	-	1	3	1
	Pyridine	C <sub>5</sub> H <sub>5</sub> N	100	1	1	4	1	3	4	4	4	1	4	1
	Resorcinol	C <sub>6</sub> H <sub>6</sub> O <sub>2</sub>	5	1	4	2	3	1	4	2	-	1	-	2
	Silver nitrate	AgNO <sub>3</sub>	100	1	1	1	1	1	1	1	1	1	2	4

## 11 Appendix

- no data 1 resistant 2 practically resistant 3 partially resistant 4 not resistant		Concentration	High Density Polyethylene	Polyamide	Polycarbonate	Polyoxymethylene	Polypropylene	Polysulfone	Polyvinyl chloride, hard	Polyvinyl chloride, soft	Polytetrafluorethylene	Acrylonitrile-butadiene-caoutchouc	Aluminium
			[%]	HDPE	PA	PC	POM	PP	PSU	PVC	PVC	PTFE	NBR
Medium	Formula												
	Sodium bisulphite	NaHSO <sub>3</sub>	10	1	1	2	4	1	-	-	1	1	1
	Sodium carbonate	Na <sub>2</sub> CO <sub>3</sub>	10	1	1	1	1	1	-	-	1	-	3
	Sodium chloride	NaCl	30	1	1	1	1	1	1	1	1	1	3
	Sodium hydroxide	NaOH	30	1	1	4	1	1	1	1	1	2	4
	Sodium hydroxide	NaOH	50	1	1	4	1	1	1	-	1	2	4
	Sodium sulfate	Na <sub>2</sub> SO <sub>4</sub>	10	1	1	1	1	1	1	1	1	1	1
	Spirits	C <sub>2</sub> H <sub>6</sub> O	96	1	1	1	1	1	1	3	1	-	1
	Styrene	C <sub>8</sub> H <sub>8</sub>	100	4	1	4	1	3	-	4	4	4	1
	Sulphuric acid	H <sub>2</sub> SO <sub>4</sub>	6	1	4	1	4	1	1	1	-	1	2
	Sulphuric acid	H <sub>2</sub> SO <sub>4</sub>	fuming	4	4	4	4	4	4	4	4	1	4
	Tallow	—	100	1	1	1	1	1	-	1	1	1	1
	Tetrahydrofuran (THF)	C <sub>4</sub> H <sub>8</sub> O	100	3	1	4	1	3	4	4	4	1	3
	Tetrahydronaphthalene	C <sub>10</sub> H <sub>12</sub>	100	3	1	4	1	4	4	4	4	1	-
	Thionyl chloride	Cl <sub>2</sub> SO	100	4	4	4	2	4	4	4	4	1	-
	Tin chloride	SnCl <sub>2</sub>	10	1	4	2	2	1	-	-	-	1	1
	Transformer oil	—	100	1	1	3	3	1	1	1	-	1	1
	Trichloroethane	C <sub>2</sub> H <sub>3</sub> Cl <sub>3</sub>	100	3	3	4	2	4	4	4	4	1	4
	Urea	CH <sub>4</sub> N <sub>2</sub> O	10	1	1	1	1	1	-	-	-	1	1
	Urine	—	100	1	1	1	1	1	-	1	1	1	-
	Vinegar	C <sub>2</sub> H <sub>4</sub> O <sub>2</sub>	10	1	4	1	1	1	1	1	1	1	2
	Vinegar	C <sub>2</sub> H <sub>4</sub> O <sub>2</sub>	90	1	4	4	4	1	3	1	4	1	-
	Wax	—	100	-	1	1		1	-	-	-	1	-
	Wines	—	100	1	1	1	2	1	1	1	1	1	-
	Xylene	C <sub>8</sub> H <sub>10</sub>	100	3	1	4	1	4	4	4	4	1	4

## 11.5 EC declaration of conformity



### **EC – DECLARATION OF CONFORMITY**

The product named hereinafter was developed, designed, and manufactured in compliance with the relevant, fundamental safety and health requirements of the listed EC directives and norms.

In the event of modifications that were not authorised by us or if the product is used in a manner that is not in line with the intended purpose, this declaration will be rendered void.

<i>Product name:</i>	Laboratory centrifuge
<i>Product type:</i>	Sigma 1-16
<i>Order number:</i>	10025, 10026, 10027, 10028, 10045
<i>Directives:</i>	2006/42/EC Machinery Directive 2014/35/EU Low Voltage Directive 2014/30/EU EMC Directive 2011/65/EU RoHS Directive
<i>Normes:</i>	EN 61010-2-020:2006 EN 61000-3-2:2014 EN 61000-3-3:2013 EN 61326-1:2013

**Sigma Laborzentrifugen GmbH**

An der Unteren Söse 50  
 37520 Osterode  
 Germany

Authorised representative  
 for CE matters:  
 Eckhard Tödteberg

Osterode, 21/09/2017

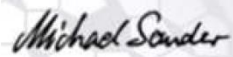

General Manager

## 11 Appendix

---



## EC – DECLARATION OF CONFORMITY

The product named hereinafter was developed, designed, and manufactured in compliance with the relevant, fundamental safety and health requirements of the listed EC directives and norms.

In the event of modifications that were not authorised by us or if the product is used in a manner that is not in line with the intended purpose, this declaration will be rendered void.

<i>Product name:</i>	Laboratory centrifuge
<i>Product type:</i>	Sigma 1-16 IVD
<i>Order number:</i>	10035, 10036, 10037, 10049
<i>Directives:</i>	98/79/EC    In vitro Diagnostica 2011/65/EU    RoHS Directive
<i>Normes:</i>	EN 61010-2-101:2002 EN 61010-2-020:2006 EN 61000-3-2:2014 EN 61000-3-3:2013 EN 61326-1:2013

### **Sigma Laborzentrifugen GmbH**

An der Unteren Söse 50  
37520 Osterode  
Germany

Authorised representative  
for CE matters:  
Eckhard Tödteberg

Osterode, 21/09/2017

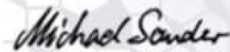

General Manager

## 11 Appendix

---

## 11.6 Declaration of conformity – China RoHS 2



### DECLARATION OF CONFORMITY

#### China RoHS 2 (Administrative Measures for the Restriction of the Use of Hazardous Substances in Electrical and Electronic Products)

Laboratory centrifuge models: Sigma 1-14, 1-14K, 1-7, 1-16, 1-16K, 2-7, 2-16P, 2-16KL, 2-16KHL, 3-16L, 3-16KL, 3-18KS, 3-18KHS, 3-30KS, 3-30KHS, 4-5L, 4-5KRL, 4-16S, 4-16KS, 4-16KHS, 4-16KRL, 6-16S, 6-16HS, 6-16KS, 6-16KHS, 6-16KRL, 8KS, 8KBS

Sigma Laborzentrifugen GmbH has made reasonable effort to avoid the use of hazardous substances in the products it manufactures (laboratory centrifuges).

A Product Conformity Assessment (PCA) was performed in order to determine whether the concentration of harmful substances in all homogeneous materials of the component parts is above or below the MCV limit (Maximum Concentration Value limit) as defined in GB/T 26572:

Mercury and its compounds: 0.1 %      Cadmium (Cd) and its compounds: 0.01 %  
Lead (Pb) and its compounds: 0.1 %      Hexavalent chromium (Cr (VI)) and its compounds: 0.1 %  
Polybrominated biphenyls (PBB): 0.1 %      Polybrominated diphenyl ethers (PBDE): 0.1 %

表1 产品中有害物质的名称及含量  
Table 1: Name and content of hazardous substances in the product

部件名称 Component part (PCA)	有害物质 Hazardous substance					
	铅 Lead (Pb)	汞 Mercury (Hg)	镉 Cadmium (Cd)	六价铬 Hexavalent Chromium (Cr (VI))	多溴联苯 Poly-brominated biphenyls (PBB)	多溴二苯醚 Polybrominated diphenyl ethers (PBDE)
Electronic PCB, cables	X <sup>1)</sup>	○	○	○	○	○
Display	○	○	○	○	○	○
Housing	X <sup>2)</sup>	○	○	○	○	○
Base, metal, accessories	X <sup>2)</sup>	○	○	○	○	○

本表格依据SJ/T 11364的规定编制。  
This table is made according to SJ/T 11364.

## 11 Appendix



O: 表示该有害物质在该部件所有均质材料中的含量均在GB/T 26572规定的限量要求以下。  
Indicates that the content of the harmful substance in all homogeneous materials of the component part is below the limit as defined in GB/T 26572.)

X: 表示该有害物质至少在该部件的某一均质材料中的含量超出GB/T 26572规定的限量要求。(企业可在此处, 根据实际情况对上表打“X”的技术原因进行进一步说明。)  
Indicates that the content of the harmful substance in at least one homogeneous material of the component part exceeds the limit as defined in GB/T 26752. (Contact the manufacturer for further technical information according to the actual situation.)

1) Contains parts in compliance with exemptions 6c, 7c.I, 7c.II and 37 of 2011/65/EU RoHS.

2) Contains parts in compliance with exemptions 6a, 6b and 6c of 2011/65/EU RoHS.

Apart from the exemptions given in this table, none of the substances listed above have been intentionally added to the product or metallic coatings.

### **Sigma Laborzentrifugen GmbH**

An der Unteren Söse 50  
37520 Osterode  
Germany

Osterode, 20/11/2017



General Manager



## 12 Index

### A

Acceleration time	
- see also the softstart and softstop function	
.....	33
Accessories, cleaning and care.....	41
Acid.....	20, 40, 41
Adapters .....	41
Alkaline solutions .....	20, 40, 41
Ambient conditions.....	50
Ambient temperature .....	50
Anodised coating .....	41
Application examples .....	13
Autoclaving .....	44

### C

Calling up stored programs .....	35
Capacity.....	49, 50
Capillary tubes .....	28
CE mark in compliance with the directive 2006/42/EC .....	15
Centrifugation of infectious, toxic, radioactive, or pathogenic substances.....	19
Centrifugation principle .....	13
Centrifugation with low capacity .....	29
Centrifuge cannot be started.....	36
Centrifuge decelerates during operation ....	36
Centrifuge, cleaning and care .....	40
Changes in colour.....	44
Changes in structure.....	44
Changing the runtime during centrifugation	32
Changing the speed/RCF value during centrifugation.....	31
Chemical and biological safety.....	19
Chemical resistance of plastic.....	41
China RoHS 2 – Declaration of conformity.	63
Cleaning agents.....	43
Cleaning the bores of angle rotors .....	41
Cleaning the centrifuge .....	40
Closing the lid .....	18, 26
Communication error .....	38
Condensation.....	25
Connected load.....	49, 50
Contamination.....	19, 41

Continuous heat resistance.....	43
Continuous run .....	33
Copyright .....	10
Corrosion .....	18, 21, 29, 40, 41, 42
Cost estimate.....	46
Cracking .....	41
Cracks .....	42
Current consumption.....	49, 50
Customer-provided fuses .....	25
Cycles.....	27

### D

Damage of the surface.....	42
Dangerous goods.....	20
Dangerous materials.....	43
Deceleration time	
- see also the softstart and softstop function	
.....	33
Declaration of conformity .....	10, 59
Declaration of conformity – China RoHS 2.	63
Declaration of decontamination.....	46, 48
Decontamination agent .....	41, 43
Deformation of tubes.....	44
Density.....	12, 20
Different service life of rotors and accessories	
.....	21, 54
Dimensions .....	23
Direct hazard to the life and health.....	16
Directive 2002/96/EC .....	48
Disinfectants .....	43
Disinfection of the rotor chamber and accessories .....	43
Disposal of the centrifuge.....	48
Disposal of the packaging .....	48
Documentation.....	10

### E

Earth conductor check .....	22
EC declaration of conformity .....	10, 59
EEPROM error.....	38
Electrical connection .....	49, 50
Electrical safety.....	18
Emergency lid release .....	37
Error correction .....	36

## Index

Error messages .....	36	Lid cannot be opened .....	36
Explanation of the symbols and notes .....	16	Lid error .....	38
Explosive substances .....	19	Lid is not closed correctly .....	36
<b>F</b>		Lid lock device .....	21
Fatal error .....	36	Lid lock has not released .....	36
Fire preventions .....	19	Lid lock is not closed correctly.....	36
Form for the return of defective parts .....	46	Lid seal sticks .....	36
Functional and operating elements .....	11	<b>M</b>	
<b>G</b>		Mains power switch off.....	36
General conditions .....	9	Mains voltage.....	18
General malfunctions .....	36	Maintenance .....	40
Glass breakage.....	42	Malfunction .....	36
Glass particles .....	42	Malfunctions and error correction.....	36
Gravitational field .....	28, 49, 50	Manual release of the lid lock.....	37
Grease for load-bearing bolts.....	40	Manufacturer.....	49, 50
<b>H</b>		Marking of the unit .....	15
Hazard warnings .....	9, 27, 29	Measures in the event of hazards and accidents .....	22
Highly corrosive substances .....	18	Mechanical safety .....	18
<b>I</b>		Microhaematocrit rotor .....	42
Imbalance .....	29	Mode of operation .....	13
Imbalance error.....	38	Motor error .....	38
Importance of the operating manual.....	9	Motor shaft.....	40
Important information .....	16	<b>N</b>	
Infectious substances .....	43	Name plate .....	12
Inflammable substances .....	19	No indication on the display .....	36
Informal safety instructions .....	17	No power in the mains supply .....	36
Initial start-up .....	26	Noise level .....	49, 50
Input fuse .....	12, 49, 50	Nominal voltage .....	12
Inspection by the manufacturer .....	45	Notes on safety and hazards .....	9
Installation of a microhaematocrit rotor .....	28	Notes on transport .....	23
Installation of a rotor .....	27	<b>O</b>	
Installation of accessories .....	29	Online download of forms .....	47
Installation of rotors and accessories .....	27	Opening the lid.....	26
Installation site .....	25	Operating personnel .....	17
Intended use .....	9	Operating voltage.....	25
Interrupting a centrifugation run .....	31	Operational safety.....	41
Interrupting a deceleration process .....	31	Overseas shipping .....	23
IP code .....	49, 50	<b>P</b>	
<b>K</b>		Packaging .....	24
Kinetic energy .....	12	Parameter .....	28
<b>L</b>		Parameter error .....	38
Layout of the centrifuge.....	11	Pathogenic substances.....	19, 40, 43
Leaks.....	44	Plastic accessories, cleaning and care.....	41

Potential hazard to the life and health .....	16	Serial number .....	12, 39, 45
Potentially hazardous situation.....	16	Service.....	45
Power consumption .....	12, 49, 50	Service contact .....	39
Power cord is not plugged in.....	36	Service life .....	40
Power supply .....	25	Service life of rotors and accessories... 21, 54	
Pressure marks.....	42	Service life of the accessories.....	44
Prevention of accidents.....	9	Service work .....	45
Problem description .....	46	Set-up and connection .....	25
Process error .....	38	Short run.....	32
Programs .....	35	Softstart and softstop function.....	33
Protection class .....	25, 49, 50	Solvents.....	20, 40, 41
<b>Q</b>		Spare part enquiries.....	39
Quick run .....	32	Speed .....	12, 14, 31, 49, 50
<b>R</b>		Speed-gravitational-field-diagram .....	53
Radioactive substances .....	19, 40	Speedometer error.....	38
Radius .....	14	Spincontrol Basic .....	30
RCF .....	31	Standards and regulations .....	10
Relative centrifugal force (RCF) .....	14, 31	Standstill monitoring system .....	22
Remove glass particles and metal dust from the rotor chamber .....	43	Starting a centrifugation run .....	31
Responsibility of the operator.....	17	Sterilisation of the rotor chamber and accessories .....	43
Return of centrifuges, spare parts, or accessories .....	46	Storage and transport .....	23
Return of defective parts .....	46	Storage conditions .....	23
Risk of electrical shock.....	18	Stress-corrosion	
Rotor chamber .....	40	see	
Rotor radii .....	52	corrosion .....	42
Rotor wrench .....	27	Structural changes.....	19
Rotors and accessories with a different service life .....	21, 54	Supply voltage .....	25
Rotors, cleaning and care .....	42	Switching the centrifuge off .....	35
Runtime .....	32	System check .....	22
<b>S</b>		System error .....	38
Safety area .....	20	<b>T</b>	
Safety devices .....	21	Table of error codes.....	38
Safety distance .....	18, 20, 25	Table of rotors and accessories with a different service life .....	21, 54
Safety instructions.....	9, 27, 29	Technical data .....	49, 50
Safety instructions for centrifugation .....	20	Technical documentation .....	51
Safety of rotors and accessories .....	21	Temperature error.....	38
Safety, chemical and biological .....	19	Temperature value cannot be reached.....	36
Safety, electrical .....	18	Thermal stress .....	40
Safety, mechanical.....	18	Toxic substances .....	19, 40
Saving the current settings.....	35	Transport safety device.....	24
Scope of supply .....	10	Type.....	12, 49, 50
		Type of connection.....	25
		Type of the centrifuge .....	39, 45

**Index**

---

**U**

Units of protection class I ..... 25  
User interface ..... 30  
UV radiation ..... 25, 40

**V**

Vents ..... 25

**W**

Warranty and liability ..... 9  
Wear ..... 45  
Weight ..... 23  
Work on the power supply system ..... 18

**Y**

Year of manufacture ..... 12