

# MACO BIOTECH *Collection* Cord blood containers

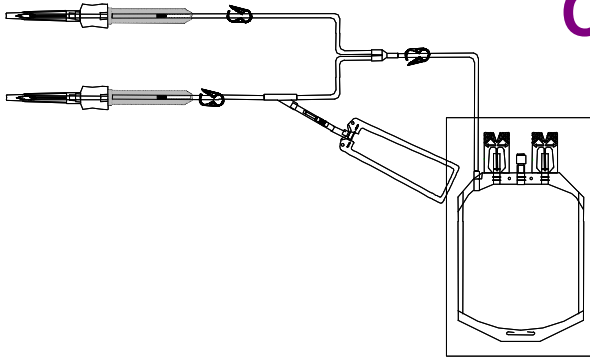

Cord Blood



Ref. MSC1201DU

## Specification

- . **Bag** : 1 PVC
- . **Solutions** : 21 mL CPD in the collection bag and 8 mL CPD in the rinsing bag
- . **Collection** : 150 mL
- . **Label** : English, French, Spanish, Italian
- . **Included items** : 2 needles with Secuvam, 1 rinsing bag, 1 protection sachet, 1 injection site
- . **Sterilisation** : Steam
- . **Shelf life** : 1 year
- . **Packaging** : 1 pack/peelable sachet, Double packaged - 12 packs/box

## Use

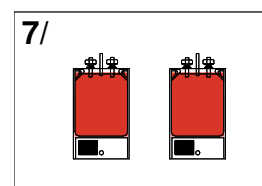
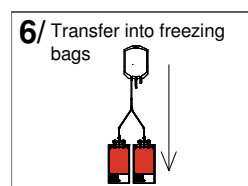
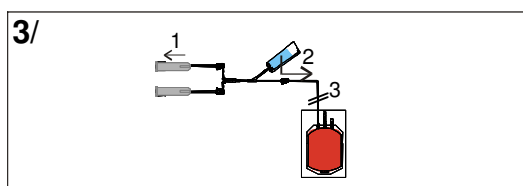
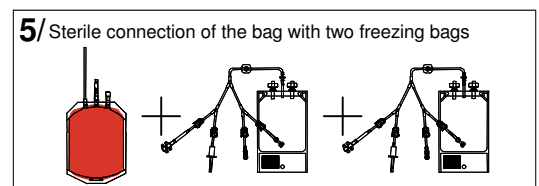
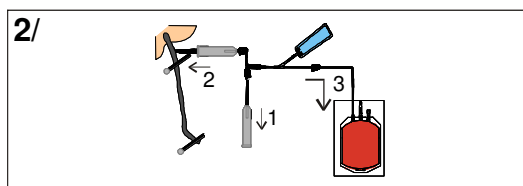
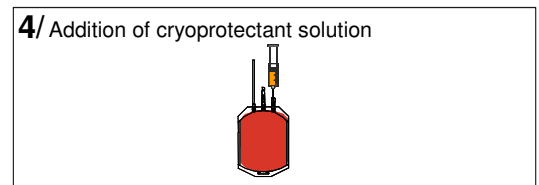
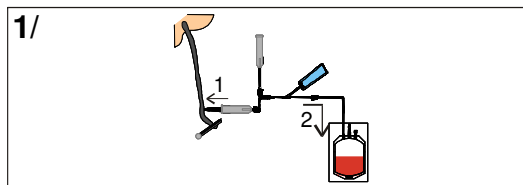

■ Sang total  
 ■ CGR  
 ■ Plasma  
 ■ MB PLASMA  
 ■ PRP  
 ■ Plaquettes  
 ■ SAG-M PAGGS-M CPD  
 ■ NaCl  
 ■ Buffy Coat  
 ■ Serum  
 ■ Surnageant



**MacoPharma**  
F - 59420 MOUVAUX