

Collection Bags

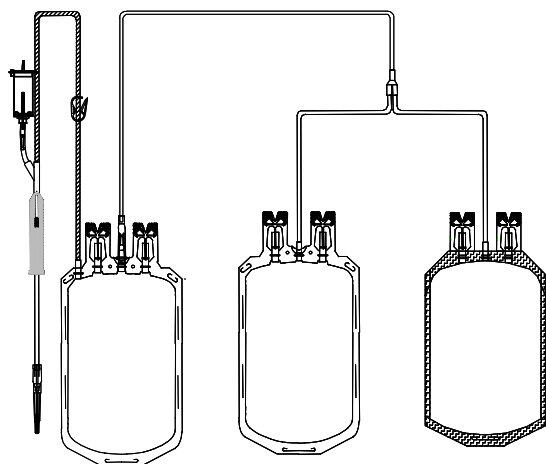

Red Cell Concentrate
Plasma
Buffy-Coat
Platelets Concentrate

Numbered Tubing

Standard bag

Platelet Storage bag (TOTM)

CE 0459

Ref. MRE6505PQ

Specifications

- . **Bags** : 3 PVC (1 TOTM)
- . **Solution** : 63 mL CPDA1
- . **Collection** : 450 mL +/- 10%
- . **Included items** : Vacuam, Secuam
- . **Labels** : French, English, German, Dutch
- . **Sterilisation** : Steam
- . **Shelf life** : 18 months
- . **Packaging** : 1 pack/peelable sachet - 15 packs/box

Use

Hard Centrifugation

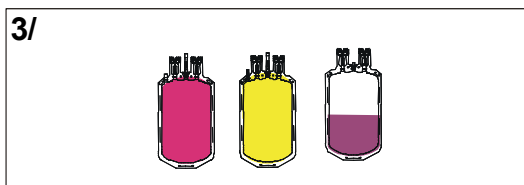
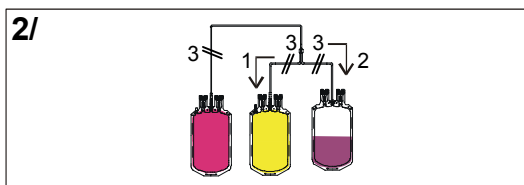
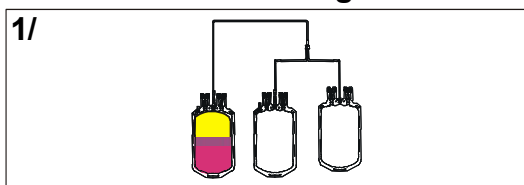

Soft Centrifugation

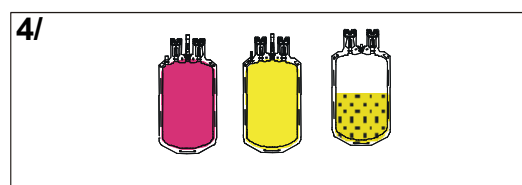
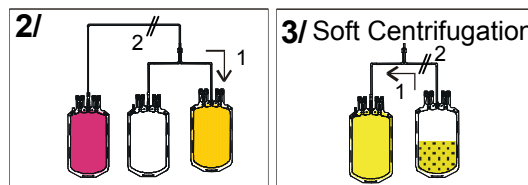
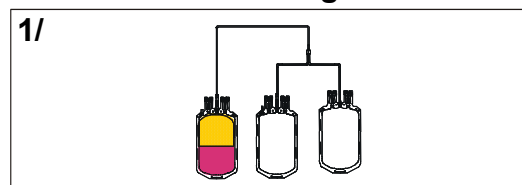

■ Whole Blood
 ■ RCC
 ■ PLASMA
 ■ MB PLASMA
 ■ PRP
 ■ Platelets
 ■ SAG-M PAGGSM
 ■ NaCl
 ■ Buffy Coat
 ■ Serum
 ■ Supernatant
 ■ Cryoprecipitate

Certified ISO 9001
Certified ISO 13485

MacoPharma
F - 59420 MOUVAUX

23/09/2005

MRE6505PQ_A_A

Blood Bags

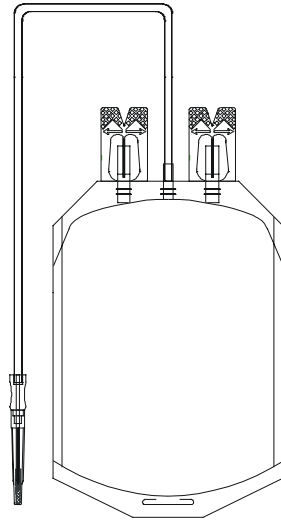

Single Bag
250ml, CPDA-1

Ref. MSE 3500Q

Specifications

. **Bag** : 250ml PVC

. **Solutions** : 35ml CPDA-1

. **Labels** : Four-language label

Lot number in Codabar format

Use

- Collection of 250ml (+/-10%) whole blood

Packaging

1 bag / peelable sachet - 35 bags / box



Blood Bags

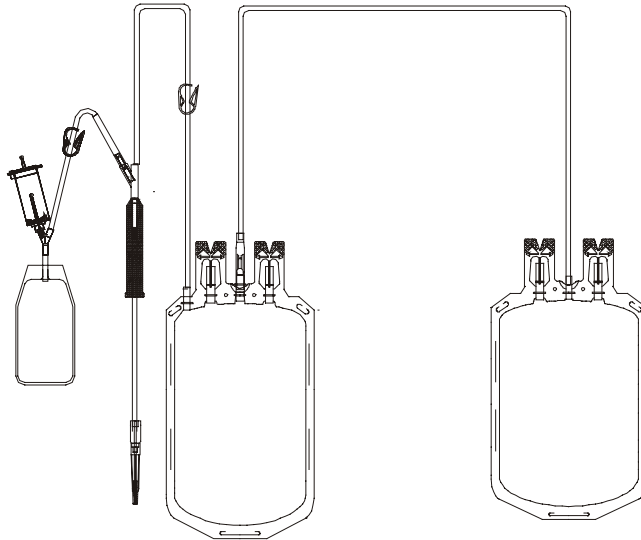

Double Bag
450ml, CPDA-1

Ref. MDE 6500LQ

Specifications

- . **Bags** : 450ml PVC
- . **Solutions** : 63ml CPDA-1

- . **Supplementary devices** :
Vacuam, Secuam, Bactivam
- . **Labels** : four-language label

Use

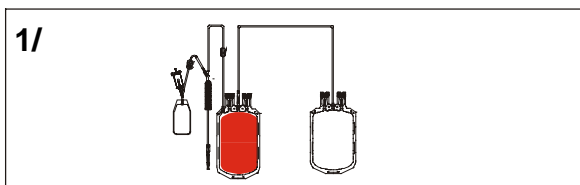

4/ **Final Products**

- A Red Cell Concentrate
- A fresh plasma

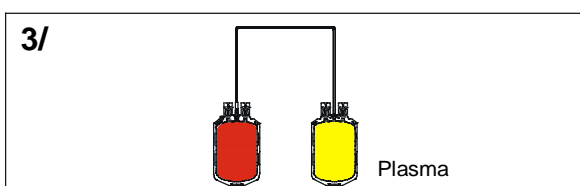
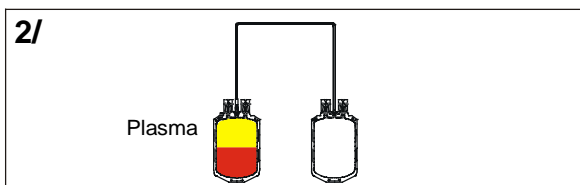

Packaging

1 bags / peelable sachet - 20 bags / box



Blood Bags

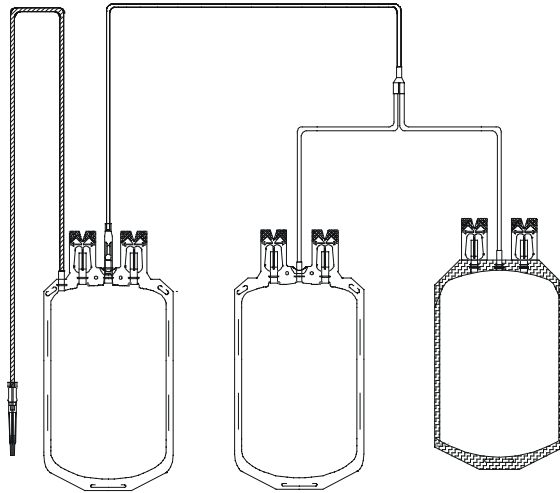

Triple Bag
450ml, CPDA1
Special Platelets

Ref. MRE 6505 Q

Specifications

- . **Bags** : 450ml PVC
Transfer bag made in TOTM
- . **Solution** : 63ml CPDA1
- . **Label** : Four language label

Use

Hard Centrifugation

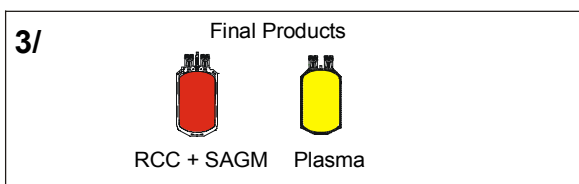
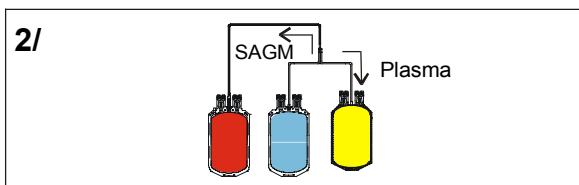
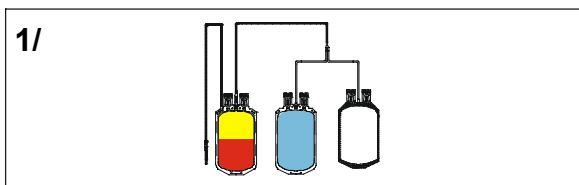

Soft Centrifugation

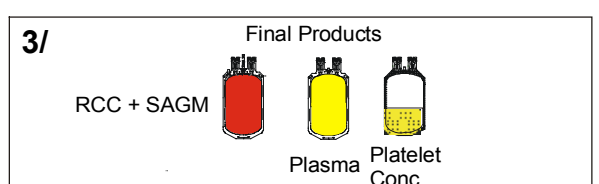
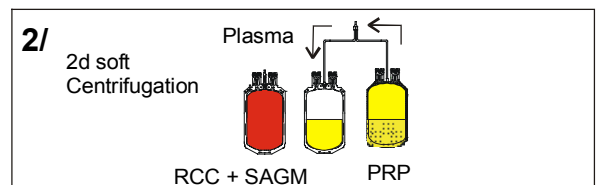
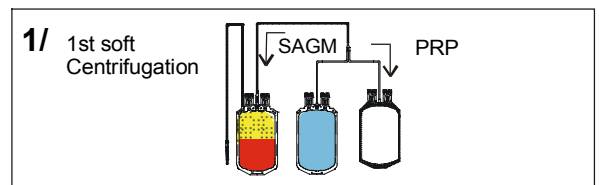

Packaging

1 bag / peelable sachet - 20 bags / box



Blood Bags

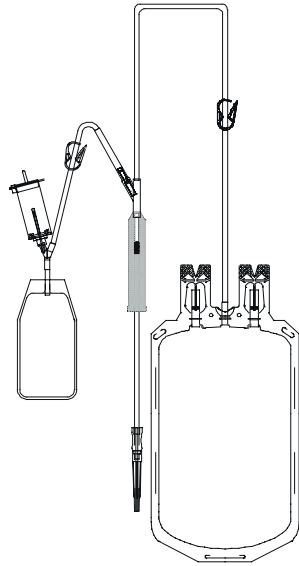

Single Bag
450ml, CPDA-1

Ref. MSE 6500L

Specifications

- . **Bags** : 450ml PVC
- . **Solutions** : 63ml CPDA-1
- . **Supplementary devices** :
Vacuam, Secuam, Bactivam
- . **Labels** : French
Lot number in Codabar format

Use

- Collection of 450ml (+/-10%) whole blood

Packaging

1 bags / peelable sachet - 25 bags / box



Blood Bags

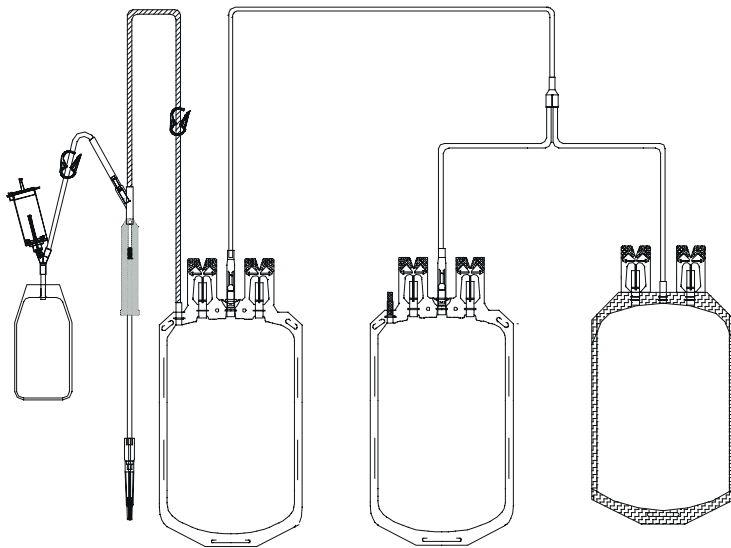

Triple Bag
450ml, CPD/SAGM
Special Platelets

Ref. MRE 6285LQ

Specifications

- . **Bags** : 450ml PVC
Transfert bag made in TOTM
- . **Solutions** : 63ml CPD, 100ml SAGM
- . **Supplementary devices** : Vacuam, Secuam, Bactivam
- . **Labels** : four-language label

Use

Hard Centrifugation

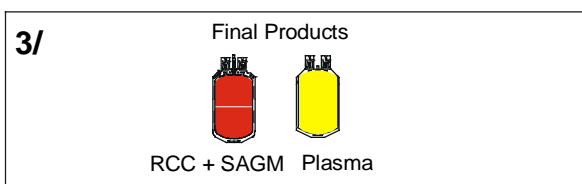
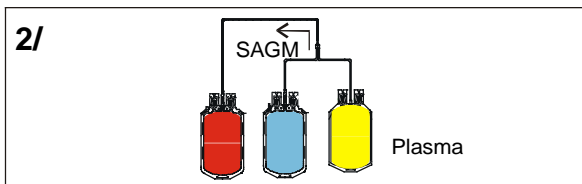
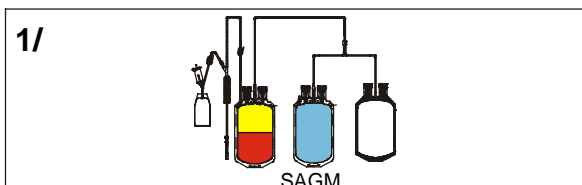

Soft Centrifugation

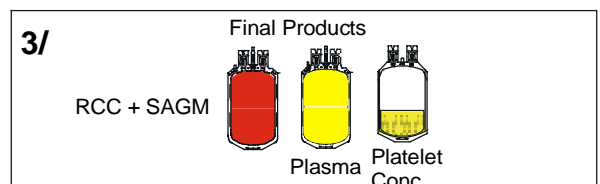
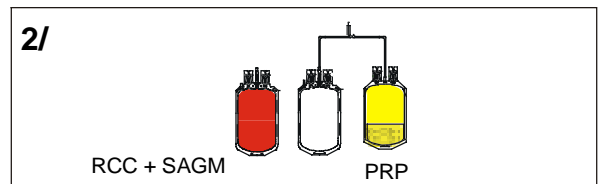
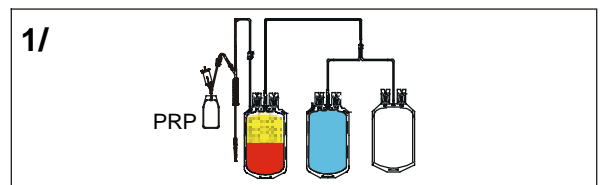

Packaging

1 bag / peelable sachet - 15 bags / box

